

APT3100

APT3100 Smart Pressure Transmitter
Operation Manual



www.sms-tork.com

*Information on this manual can be changed without an advance notice.

APT3100

APT3100 Smart Pressure Transmitter

This manual is made available to assist general users with instructions for proper installation and operation of an Autrol® APT3100 Smart Pressure Transmitter. Before handling the APT3100 transmitter, all users should read this manual to familiarize with recommended practices.

Please note that information on this manual can be changed without any advance notice. Please contact AAI or our local representatives for any updates.

APT3100

Table of Contents

Chapter 1. Introduction

- 1.1 Using this manual
- 1.2 Overview of the transmitter
- 1.3 Software Compatibility
- 1.4 Transmitter Components

Chapter 2. Handling

- 2.1 Unpacking and specifications Check
- 2.2 Models and specifications Check
- 2.3 Storage
- 2.4 Selecting a suitable location for installation
- 2.5 Performing Zero Trim after First installation
- 2.6 Pressure Connection
- 2.7 Waterproofing of Cable Conduit
- 2.8 Restrictions on Use of Radio Transceivers
- 2.9 Insulation Resistance Test and Dielectric Strength Test
- 2.10 Installation of Explosion Proof Transmitters in Classified Areas
- 2.11 EMC Conformity Standards

Chapter 3. Transmitter Functions

- 3.1 Overview
- 3.2 Safety Messages
- 3.3 Warning
- 3.4 Fail Mode Alarm
- 3.5 EEPROM-Write Enable and Disable Mode Jumper
- 3.6 Configuration of Alarm and Security Jumper Procedures
- 3.7 Configuration using Zero and Span Push Buttons
- 3.8 Commissioning on the bench with a HHT (Hand Held Terminal)

Chapter 4. Installation

- 4.1 Overview
- 4.2 Safety Messages
- 4.3 Warning
- 4.4 Commissioning on the bench with a Hand-Held Terminal
- 4.5 General Considerations
- 4.6 Electrical Considerations
- 4.7 Wiring
- 4.8 Mechanical Considerations
- 4.9 Environmental considerations

APT3100

Chapter 5. On-line Operation

- 5.1 Overview
- 5.2 Safety Messages
- 5.3 Configuration Data Review
- 5.4 Check Output
- 5.5 Basic Setup
- 5.6 Detail Setup
- 5.7 Tag Information Setup
- 5.8 Diagnostic Services
- 5.9 Calibration
- 5-10 Advanced Setup

Chapter 6. Maintenance

- 6.1 Overview
- 6.2 Safety Messages
- 6.3 Hardware Diagnostics
- 6.4 Hardware Maintenance

Appendix I

APT3100 Smart Pressure Transmitter
LCD Display Code

Appendix II

APT3100 Smart Pressure Transmitter
Quick Push Button Menu guide.

Appendix III

APT3100 Smart Pressure Transmitter
HHC HART® Handheld Communicator User's Guide

HART® is a registered Trademark of HART® Foundation

APT3100

Chapter1 Introduction

The APT3100 Smart Pressure Transmitter is accurately calibrated at the factory before shipment. If attempting to recalibrate these transmitters in field please ensure to use a calibration source at least five times more accurate than transmitter published specifications. To ensure correct and efficient use of the instrument, please read this manual thoroughly and fully understand how to operate the instrument before installation.

- The contents of this manual are subject to change without prior notice.
- All rights reserved. No part of this manual may be reproduced in any form without AUTROL® AMERICA's written permission.
- For questions, errors or missing information found in this manual, please inform the nearest AUTROL® AMERICA's sales office or email info@Autroltransmitters.com.
- The specifications covered by this manual are limited to standard configured items as specified within published ordering codes and does not cover custom-made instrument designated with code "X" within its model code.
- Please note that changes in the specifications, construction, or component parts of the instrument may not immediately be reflected in this manual at the time of change, provided that postponement of revisions will not cause difficulty to the user from a functional of performance standpoint.

1.1 Using This Manual

The Chapters in this operating manual provide information on installing, operating, and maintaining an AUTROL® Model APT3100 Smart Pressure Transmitter. Chapters within this manual are organized as follows.

Chapter 1 Introduction

Chapter 2 Handling

Chapter 2 provides instructions on software functions, configuration parameters, and on-line variables.

Chapter 3 Transmitter Functions

Chapter 3 contains instructions for configuring and commissioning a Autrol® APT series Smart Pressure Transmitters.

Chapter 4 Installation

Chapter 4 contains mechanical, environment and electrical installation instructions for Autrol® APT series Smart Pressure Transmitters.

Chapter 5 On-line Operation

Chapter 5 describes the configuration process and how to use basic and advanced Autrol® APT series Smart Pressure Transmitter software functions during configuration. Included in these sections are details on using:-

- ① Sensor or Output Trim
- ② Changing range configuration, Output Type, Damping, measurement units etc.
- ③ Change of general data such as Tag No., Date, Message etc.

Chapter 6 Maintenance

Chapter 6 contains hardware diagnostics ,troubleshooting and maintenance tasks.

Appendix 1 : List of Error Codes available on LCD display

APT3100

1.2 Overview of Transmitter

Autrol® APT 3100 Smart Pressure Transmitter are microprocessor based “smart” pressure transmitters. It uses a capacitive pickup optimized & accurately characterized with a patented temperature compensation algorithm for high precision & long term stable gauge and absolute pressure measurements over a wide range of operating conditions. APT3100 is a two wire loop power transmitter and has a standard 4/20mA output scaled for desired output pressure range. In addition it also offers digital HART® (digital signal superimposed over the analog output) communication that allow transmitting additional digital parameters/diagnostic information for advanced control systems like DCS, PLC, SCADA RTU etc. All APT series transmitters have an explosion proof rated housing (standard cast aluminum –copper free epoxy coated or optional SUS316) protected for outdoor NEMA 4X and/or classified hazardous areas Class I, II, III / Division 1 or 2 use.

This transmitter can be configured remotely via HART® communication through a HART® MASTER Host (AMS, PDM, PKS etc) , a HHT (HART® Hand-Held Terminal using DDL or DOF technology) or any HART® enabled PC Configurator supporting DDL technology. This allows critical variables to be changed, configured and tested remotely by users. Note: For HART® Communication a minimum 250 Ohm loop resistance is mandatory.

1.3 Software Compatibility

Autrol® Smart Pressure Transmitter's are shipped from the factory with the most up to date firmware. However as product developments and new features are released a firmware update becomes necessary to incorporate these new changes. As such transmitters with older firmware may restrict certain functions when communicating with an external HHT (Model 275 /375 or 465 HART® Communicator).

*****FOR CURRENT 7.X FIRMWARE PLEASE REFER TO ATTACHED ADDENDUM -A FOR THE LATEST MENU TREE.**

FUNCTION	Table 1.0 (Supported Functions)			
	ZERO / SPAN Bottom		Autrol® PC/PDA	HART®
	Before Rev. 66	Rev. 66+	Ver. 2.3.33+	275/375/475
ZERO/SPAN	•	•	•	•
ZERO TRIM	•	•	•	•
ZERO Adj	•	•	•	•
Units set	x	•	•	•
Range set	x	•	•	•
Damping set	x	•	•	•
LCD Decimal set	x	•	•	Δ
LCD Rotation set	X	•	•	•
Enable Eng. Mode	X	•	•	•
Configure Eng. Mode	X	X	•	Δ
DA Trim	X	X	•	•
Output Mode(sq-root)	X	X	•	•

•: Supported. x : Not Supported Δ: Supported but updated FDR5 DDL required

In this case contact AAI for a recommended firmware update or use latest FDR DDL

APT3100

(Device Description Library) to ensure compatibility of the transmitter with connected HHT, PDM etc.

Important Note: There may also be some differences on supported functions on the local push button menu based on the installed firmware revision of the transmitter. This manual is based on Firmware Revision 6.6 and higher. Actual firmware revision installed on transmitters can be identified by

- (a) Firmware version printed on neck plate (below LCD module) .
- (b) On LCD display during power up/Boot up sequence.
- (c) Via HHT or HART® UMPC in Info menu.

Menu functional enabled on new firmware Revision is highlighted in table 1.0 above.

1.4 Transmitter Components

The various components of an Autrol® APT Series Smart Pressure Transmitter is included below. For sensor exploded view see next page.

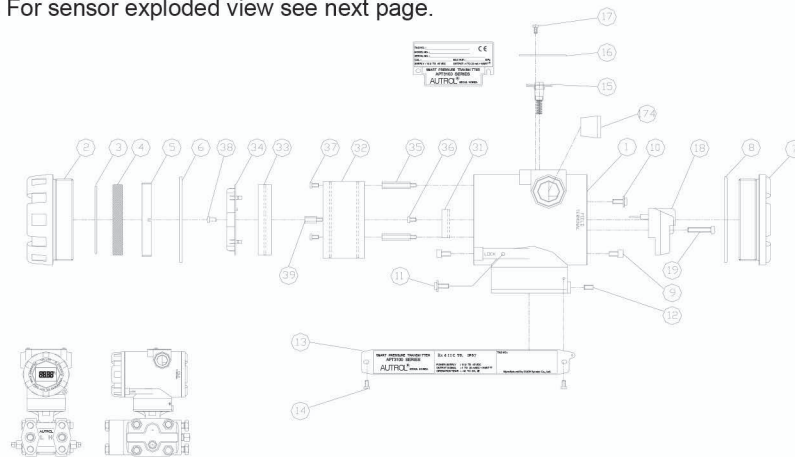
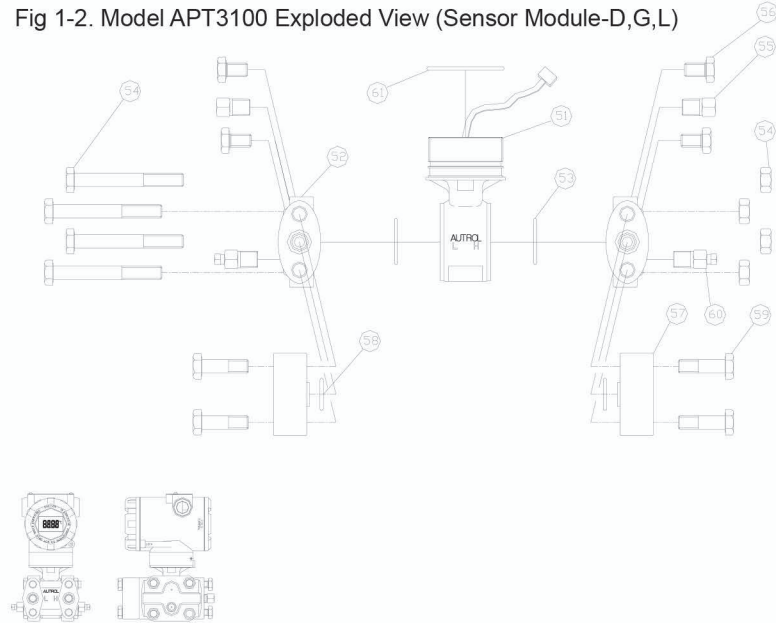

Figure 1-1. Model APT3100 Transmitter Exposed View (Housing)

NOTE :			
1	HOUSING-POLYURETHANE PLANT	16	NAME PLATE/ CERTI.
2	FRONT COVER	17	SCREW/ CERTIF. PLATE
3	O-RING/ GLASS	18	TERMINAL BLOCK
4	GLASS-TEMPERED	18-1	BODT/ T.B
5	GLASS RING NUT	18-2	SCREW/ TERMINAL
6	O-RING/ FRONT COVER	18-3	PIN/ T.B
7	REAR COVER	18-1	COMM. TEST PIN/ T.B
8	O-RING/ REAR COVER	19	SCREW/ TERMINAL BLOCK
9	SCREW/ COVER LOCK	31	ELECTRONICS/ IN-OUT
10	SCREW/ INTERNAL GROUND	32	ELECTRONICS/ MCU
11	SCREW/ EXTERNAL GROUND	33	ELECTRONICS/ LCD
12	SCREW/ HOUSING ROTATION SET	34	LCD COVER
13	NAME PLATE/ DATA & TAG	35	POST/ ELECTRONICS
14	SCREW/ NAMR PLATE	36	SCREW/ IN-OUT BOARD
15	SERO/ SPAN ADJ. SWITCH	37	SCREW/ ELECTRONICS
15-1	SWITCH/ SPRING	38	SCREW/ LCD METER
15-2	SWITCH/ MACNET	39	SCREW/ LCD METER
15-3	SWITCH/ BUTTON	74	PLUG, 1/2 NPT
15-4	SWITCH/ COVER		

APT3100

Fig 1-2. Model APT3100 Exploded View (Sensor Module-D,G,L)



NOTE :			
51	SENSOR MODULE	51-1	SENSOR
51-13	RANGE 3, 7.5 KPa	51-2	SENSOR BODY
51-14	RANGE 4, 37.3 KPa	51-3	SENSOR RING
51-15	RANGE 5, 186.5 KPa	51-4	SENSOR BOARD
51-16	RANGE 6, 690 KPa	51-5	MOLD SOLUTION
51-17	RANGE 7, 2068 KPa	52	FLANGE/ PROCESS
51-18	RANGE 8, 6895 KPa	53-1	C-RING/ FLANGE
51-19	RANGE 9, 20680 KPa	53-2	□-RING/ FLANGE
		54	BOLT & NUT / FLANGE
		55	FLANGE PLUG
		56	BOLT / BRACKET
		57	FLANGE ADAPTER
		58-1	C-RING/ FLANGE ADAPTER
		58-2	□-RING/ FLANGE ADAPTER
		59	BOLT / FLANGE ADPATER
		60	VENT / DRAIN PLUG
		61	C-RING/ SENSOR MODULE

Table 1-2. APT 3100 D,G, A, L TRANSMITTER COMPONENTS

APT3100

Fig 1-3. Model APT3100 Exploded View (Sensor Module-H)

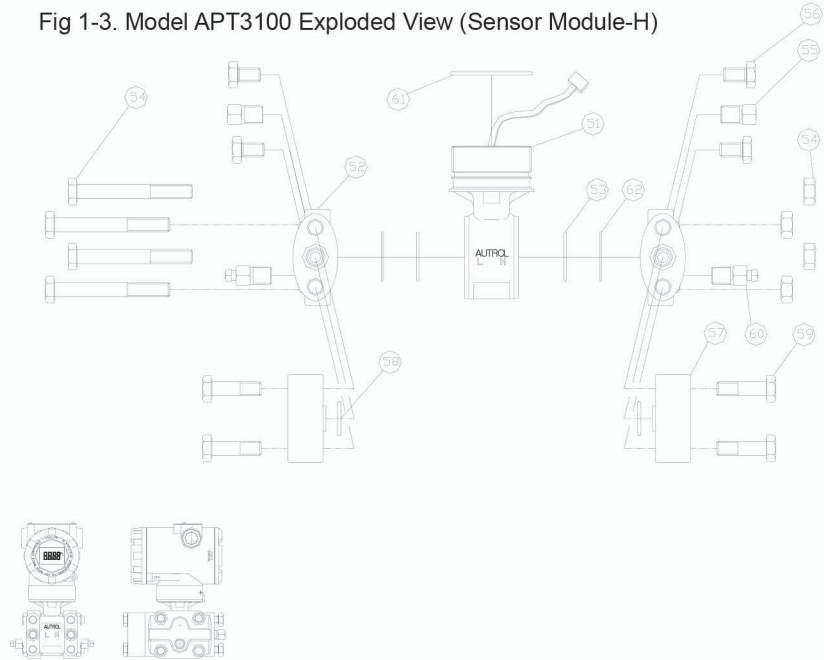

NOTE :

51	SENSOR MODULE (HIGH LINE PRESSURE)	51-1	SENSOR
		51-2	SENSOR BODY
51-H4	RANGE 4, 37.3 KPa	51-3	SENSOR RING
51-H5	RANGE 5, 186.5 KPa	51-4	SENSOR BOARD
51-H6	RANGE 6, 690 KPa	51-5	MOLD SOLUTION
51-H7	RANGE 7, 2068 KPa	52	FLANGE/ PROCESS
		53-1	C-RING/ FLANGE
		53-2	O-RING/ FLANGE
		54	BOLT & NUT / FLANGE
		55	FLANGE PLUG
		56	BOLT / BRACKET
		57	FLANGE ADAPTER
		58-1	C-RING/ FLANGE ADAPTER
		58-2	O-RING/ FLANGE ADAPTER
		59	BOLT / FLANGE ADAPTER
		60	VENT / DRAIN PLUG
		61	C-RING/ SENSOR MODULE

Table 1-3. APT 3100H TRANSMITTER COMPONENTS

APT3100

Chapter 2 Handling

This chapter includes instructions for transmitter handling, storage, selection of appropriate installation locations, insulation and cautions for hazardous area installation.

[Quick Reference Table 2.0]

Step	Job	Job Details	Instrument
1	Unpacking	- Unpack transmitter from its packing	As applicable
2	Model and Specifications Check	- Make sure whether the delivered transmitter is same as ordered and meets applications requirements	Visual Nameplate
3	Storage	- Please do not expose to rain, water, high humidity, excessive-vibration and high-impact areas - Store under ambient temperature 70F and relative humidity 65% RH	None
4	Bench Calibration	- Configuration of Range, Zero/Span, Unit, Tag, Damping Time, Transfer Function, DA Trim and other parameters.	- HHT/ Pressure calibrator-(if available) - Ammeter for output trimming.
5	Installation Locations	- Where ambient temperature is not fluctuating. - Where chemical corrosion is minimal. - Where vibration and impact is not severe - Where hazardous area is matched with explosion proof classifications defined by local regulatory bodies. - Where maintenance access is easy	(Engineering)
6	Mechanical Considerations	- Where transmitter can be handled easily - Be cautious of pressure leaks.	(Engineering)
7	Electrical Considerations	- Connect 24 Vdc (Recommended power supply is 11.9 Vdc – 45 Vdc) - For HART® communication, total resistance on transmitter terminal loop should be 250 – 550 Ohm.	(Engineering)
8	Mounting and Installation	- For mounting transmitter, an appropriate bracket (BA or BF type) should be used. - Transmitter should be fixed firmly to its bracket.	(Mounting and Installation)
9	Calibration upon installation.	- Sensor Zero Trim is highly recommended during first installation and start-up. During a Zero trim the zero baseline of transmitter is established. - Before initiating zero trim make sure that PV value of transmitter is zero and current output is at 4 mA.	Local Zero/Span button or HHT
10	Pressure	- Do not apply differential and/or full line pressure suddenly. - Close equalizing valve of 3/5 valve manifold, then, open stop valve on high and low side slowly and simultaneously.	(Manual)
11	Operation	- Verify transmitter is operating within specifications.	Visual or HHT

APT3100

2.1 Unpacking

When moving the transmitter to the installation site transfer it in its original packaging. Only unpack the transmitter on site of installation to avoid damage during transit.

2.2 Models and Specifications Check

The model name and specifications are indicated on the top nameplate fixed to the transmitters. Please check your specification and model supplied for your installation. Please ensure LRL/URL, min/max span specifications and MWP of sensor range codes are in line with your application requirements.

2.3 Storage

The following precautions must be observed when storing the instrument, especially for long period.

- (1) Select a storage area that meets the following conditions:
 - a) It is not directly exposed to rain, water, snow or sun light.
 - b) It is exposed to minimum vibration and shock.
- c) If possible, it is advisable to store at normal temperature and humidity (approx. 70°F, 65% RH). However, it can also be stored under ambient temperature and relative humidity within the following published ranges.
 - Ambient Temperature: -40 ~ 85°C (without LCD) * or -30 ~ 80°C (with module) *
 - * General use only. For explosion proof versions follow product certification reqmts.
 - Relative Humidity: 5% ~ 98% RH (at 40°C)
- (2) When storing the transmitter, repack with original (or similar) packaging that was shipped from the factory.
- (3) If storing a transmitter that has already been used, thoroughly clean all wetted parts including diaphragm seals (if installed), process connections/manifolds in contact with process fluid. In addition, make sure before storing the transmitter that remote seal (if supplied) assemblies are securely mounted.

2.4 Selecting a Suitable Location for Installation

The transmitter is designed to withstand severe environmental conditions. However, to ensure stable and accurate operation for extended years, the following precautions must be observed when selecting an installation location.

- (1) Ambient Temperature:

Avoid locations subject to wide temperature variations or a significant temperature gradient. If the location is exposed to radiant heat from plant equipment, provide adequate insulation or ventilation.
- (2) Ambient Atmosphere
Avoid installing the transmitter in a corrosive atmosphere. If the transmitter must be installed in a corrosive atmosphere, there must be adequate ventilation as well preventive measures to minimize intrusion or stagnation of rainwater or condensation build up through its electrical conduits. Moreover, there should be appropriate precautions taken to prevent corrosion build up due to condensation or moisture collected within conduits and terminal boxes over extended periods of operation. Inspect periodically as required.
- (3) Shock and Vibration:

Select an installation site subject to minimum shock and vibration. Although the transmitter is designed to be relatively resistant to shock and vibration we highly recommend following good engineering practices.
- (4) Installation of Explosion Proof rated Transmitters
Explosion proof rated transmitters must be installed in hazardous areas according to the area classification for which they are certified.
- (5) Accessibility
Always select a location that provides easy access to transmitter for

APT3100

maintenance & calibration.

2.5 Performing Sensor Zero Trim after Installation

- (1) Sensor Zero Trim should be done immediately after transmitter is installed because zero point can shift due to mounting status of the sensor pick up.
- (2) For Sensor Zero Trim, make input pressure of transmitter zero prior to initiating zero trim calibration. Any Sensor Trim done in field must be carried out after installation is finalized and with transmitter position fixed. Also if applying external pressure ensure the display is sufficiently stabilized (after approximately 10 to 15 seconds) before initiating any Trim function.
- (3) There are 3 recommendations for making input pressure "zero". One is to apply a "zero" pressure source (mandatory for absolute pressure models). Second is to apply equal pressure on both HP and LP ports (DP models only). The third option is to open equalizing valve of manifolds installed and venting to atmospheric pressure (allowed only for Gauge & DP type models only).
- (4) Sensor Zero Trim can be performed using an external HHC (Hand held calibrator), PC or PDA configurator, and/or using Zero/Span local push buttons provided on the transmitter.
- (5) When using local push buttons please refer to Chapter 3.7 of this manuals for detailed instructions. If using an external HHT or HART® PC configurator please refer to the user manuals supplied by the third party supplier.

2.6 Process Connections

Standard Process connection is ¼" NPT. Optional ½" NPT Process connection is available with use of Oval Flange adapters (O option) if ordered with the transmitter.

▲ Warning

- ◆ Instrument installed in the process is under pressure. Never loosen or tighten the flange bolts as it may cause leakage of process fluid.
- ◆ If the process fluid may be toxic or otherwise harmful, take appropriate care to avoid contactand/or exposure to direct vapors even after dismantling the instrument from process line for maintenance.

The following precautions must be observed in order to safely operate the transmitter under pressure.

- (1) Never apply a pressure higher than the maximum working pressure specified on the nameplate.
- (2) Use adequate seals for leak tight process connections and use only quality and standardized parts.
- (3) Regularly inspect for signs of leakage and apply corrective actions when necessary.

2.7 Waterproofing of Cable Conduit Connections

Apply a non-hardening sealant (viz. silicone or Teflon tape, etc.) to the threads to water proof the cable conduit entry connections.

2.8 Restrictions on Use of Radio Transceivers**▲ Warning**

APT3100

- ◆ Although the transmitter has been designed to resist high frequency electrical noise, if a radio transceiver is used near the transmitter or its external wiring, the transmitter may be affected by high frequency noise pickup. To test for such effects, bring the transceiver in use slowly from a distance of several meters from the transmitter, and observe the measurement loop for noise effects. Thereafter, always use the transceiver outside the area affected by noise.

2.9 Insulation Resistance Test and Dielectric Strength Test

All APT series transmitter are subjected to insulation resistance and dielectric strength tests (at the factory) prior to shipment. Normally these tests are not required to be duplicated in field. However, if required, observe the following precautions in the Field test procedures.

- (1) Do not perform such tests more frequently than is absolutely necessary. Even test voltages that do not cause visible damage to the insulation may degrade the insulation and reduce safety margins.
 - (2) Never apply a voltage exceeding 500 Vdc (100 Vdc with an internal lightning protector LP option) for insulation resistance test, Or a voltage exceeding 500V AC (100V AC with an internal lightning protector option) for dielectric strength tests.
 - (3) Before conducting these tests, disconnect all power and signal lines from the transmitter terminals. Follow procedures outlined below to initiate these tests.
- I. Insulation Resistance test
 - a) Short the (+) and (-) SUPPLY terminals inside the transmitter terminal box.
 - b) Turn OFF the insulation tester. Then connect the insulation tester positive (+) lead wire to the shorted SUPPLY terminals on the transmitter and the negative (-) lead wire of tester to the ground terminal on transmitter.
 - c) Turn ON the insulation tester power and measure the insulation resistance. The voltage should be applied for a short duration sufficient enough only to verify that insulation resistance measured is at least 20MΩ.
 - d) After completing the test and being very careful not to touch exposed conductors disconnect the insulation tester and connect a 100kW resistor between the grounding terminal and the short-circuiting SUPPLY terminals. Leave this resistor connected for at least three second to discharge any static potential. Do not touch the terminal while it is discharging.
 - II. Dielectric Strength Test
 - a) Short-circuit the (+) and (-) SUPPLY terminals marked in the terminal box.
 - b) Turn OFF the dielectric strength tester. Then connect the tester between the shorted SUPPLY terminal and the ground terminal of transmitter.
 - c) Be sure to connect the grounding lead of the dielectric strength tester to the ground terminal.
 - d) Set the current limit on the dielectric strength tester to 10mA, then turn ON the power and gradually increase the tester voltage from '0' to the specified voltage. When the specified voltage is reached, hold it for one minute. After completing this test, slowly decrease the voltage to avoid any voltage surges.

2.10 Installation of Explosion Proof Transmitters in Classified Areas

Installation

- All wiring shall comply with local installation requirement.
- Cable Glands shall be suitable for the environment and shall be certified as explosion proof.
- Unused conduit opening shall be properly sealed with certified metallic plugs.
- Grounding procedure must be followed in compliance to "local electrical codes". Recommended to us a qualified grounding earth with least impedance. Grounding options:

APT3100

* Internal Ground Connection: An Internal ground connection screw is located inside the terminal housing accessible by opening the rear cover. The ground screw can be easily identified from its ground symbol marking.

* External Ground Lug: This is located on the right side of housing and accessible from outside. This ground screw can also be easily identified from its ground symbol marking.

- When use metallic conduits, stopping boxes must be used.
- All Cable Glands must be certified as explosion proof for area classification.
- Conduit thread must be engaged with a minimum of 5 thread connections.
- Process Connection should also be engaged with a minimum of 7 thread connections and housing rotation set screw (below front cover) tightened to prevent housing from rotating.

Operation

- Wait one minute after disconnecting power, before opening the enclosure.
- Take care not to generate mechanical spark when accessing the instrument and peripheral devices in hazardous location.

[Maintenance and Repair

- The instrument modification or parts replacement by other than authorized factory representative is prohibited and will void flameproof certification.

2.10.1 KOSHA Certification

Caution for KOSHA Flameproof is following type.

[Note1] Model APT3100 sealed for potentially explosive atmosphere:

- Type of Protection and Marking Code: Ex d II C T6
- Temperature Class: T6
- Ambient Temperature: -20 ~ 60°C
- Process Temperature: Max. 80°C

[Note2] Electrical Data

- Supply Voltage: Maximum 45 Vdc
- Output signal: 4 ~ 20mA, maximum 22mA

2.10.2 KEMA / ATEX Certification

ATEX Certification number : KEMA05ATEX2244

CE XXXX  II 2 G

Note 1. Model APT3100 for potentially explosive atmosphere

- Ex d IIC T6
- Operating Temperature : $-20^{\circ}\text{C} \leq T_{\text{amb}} \leq +60^{\circ}\text{C}$
- T6 for process $< 85^{\circ}\text{C}$;
- T5 for process $< 100^{\circ}\text{C}$;
- T4 for process $< 120^{\circ}\text{C}$

Note 2. Electrical Data

- Supply Voltage : 45 Vdc Max
- Output Signal : 4 to 20 mA + HART®

Note 3. Electrical Connection: 2 x 1/2-14NPT Female

Note 4. APT3100 ATEX Certification is according to the below standards EN 60079-0
EN 60079-1

APT3100

2-10-4. Factory Mutual (FM)USA Certification to NEC codes

HAZARDOUS LOCATION ELECTRICAL EQUIPMENT

APT3100-abclgjkkm. Pressure Transmitters.

APT3100-abcdefgijklm. Pressure Transmitters.

APT3100-abcdfghiklm. Pressure Transmitters.

XP/II/1/ABCD/T6 Ta = 60 °C ;

DIP/II, III/1/EFG/T6 Ta = 60 °C ;

NI/II/2/ABCD/T4 Ta = 60 °C ;

S/II/2/EFG/T4 Ta = 60 °C ;

S/III/1/T4 Ta = 60 °C ;

Type 4X/IP67.

a = Transmitter Type D, G, H, LEC, LED, LES, LFC, LFD or LFS.

b = Ranges : 3, 4, 5, 6, 7, 8 or 9.

c = Mounting Flange Size & Material : C1, C2, C4, M11, M12, M13, M14, M21, M22, M23, S2, S3 or S4

d = Mounting Flange Rating : A1, A2, D1, D2, J1, J2 or XX.

e = Extension Length : 05, 10, 15 or XX.

f = Wetted Parts Material : H, S or X.

g = Fill Fluid : 1, 2, 7 or X

h = Capillary Length : 01, 02, 03, 04, 05, 06, 07, 08, 09, 10, 11 or 12.

i = Material of Construction : CS or SS.

j = Low Side : N, W or X.

k = Electrical Connection : 1.

l = Hazardous Location Certification : F1.

m = Option : BA, BF, C6, CA, CF, K, M1, P, S or TW.

Equipment Rating :Explosionproof for use in Class I, Division 1, Groups A, B, C &D; Dust-Ignitionproof for Class II/III, Division 1, Groups E, F and G; Nonincensive for use in Class I, Division 2, Groups A, B, C and D; Suitable for use in Class II, Division 2, Groups E, F and G; and Suitable for Class III, Division 1; Hazardous(classified) location, indoor and outdoor (NEMA Type 4X/IP67).

2-10-4. FM Canada Certification confirming to CSA Standards

HAZARDOUS LOCATION ELECTRICAL EQUIPMENT

APT3100-abclgjkkm. Pressure Transmitters.

APT3100-abcdefgijklm. Pressure Transmitters.

APT3100-abcdfghiklm. Pressure Transmitters.

APT3100

XP/II/1/ABCD/T6 Ta = 60°C;

DIP/II, III/1/EFG/T6 Ta = 60°C;

NI/II/2/ABCD/T4 Ta = 60°C;

S/II/2/EFG/T4 Ta = 60°C;

S/III/1/T4 Ta = 60°C;

Type 4X/IP67.

a = Transmitter Type D, G, H, LEC, LED, LES, LFC, LFD or LFS.

b = Ranges : 3, 4, 5, 6, 7, 8 or 9.

c = Mounting Flange Size & Material : C1, C2, C4, M11, M12, M13, M14, M21, M22, M23, S2, S3 or S4

d = Mounting Flange Rating : A1, A2, D1, D2, J1, J2 or XX.

e = Extension Length : 05, 10, 15 or XX.

f = Wetted Parts Material : H, S or X.

g = Fill Fluid : 1, 2, 7 or X

h = Capillary Length : 01, 02, 03, 04, 05, 06, 07, 08, 09, 10, 11 or 12.

i = Material of Construction : CS or SS.

j = Low Side : N, W or X.

k = Electrical Connection : 1.

l = Hazardous Location Certification : F1.

m = Option : BA, BF, C6, CA, CF, K, M1, P, S or TW.

Equipment Rating : Explosionproof for use in Class I, Division 1, Groups A, B, C & D; Dust-Ignitionproof for Class II/III, Division 1, Groups E, F and G; Nonincensive for use in Class I, Division 2, Groups A, B, C and D; Suitable for use in Class II, Division 2, Groups E, F and G; and Suitable for Class III, Division 1; Hazardous(classified) location, indoor and outdoor (NEMA Type 4X/IP67).

2.11 EMC Conformity Standards

EMI (Emission): EN55011

EMS (Immunity): EN50082-2

AAI recommends customer to follow installation requirement conforming to EMC Regulations or to plant standards.

APT3100

Chapter 3 Transmitter Functions

3.1 Overview

This chapter includes instructions to facilitate pre-installation set up procedures for an AUTROL®APT series SMART Pressure transmitter. Tasks that can be performed on the bench prior to installation in the field are also explained in this chapter.

3.2 Safety Message

Procedures and instructions in this chapter may require special precautions to ensure the safety of the personnel performing these operations. Information that raises potential safety issues is indicated by warning symbol (▲). Refer to the following safety messages before performing an operation preceded by this symbol.

3.3 Warning

▲ Warning

Electrical can result in death serious injury:

- ◆ Avoid contact with the leads and terminals. High voltage that may be present on leads can cause electrical shock.

▲ Warning

Explosion can result in death or serious injury:

- ◆ Do not remove the transmitter covers in hazardous locations when the circuit is live.
- ◆ Transmitter covers must be fully engaged to meet explosionproof approval requirements.

▲ Warning

Electrical can result in death serious injury:

- ◆ Only qualified & trained personnels should be allowed to operate these transmitter.

3-4. Fail Mode Alarm

AUTROL® Smart Pressure Transmitter automatically performs real time self-diagnostic routines and displays any error codes on its local LCD (M1 option if ordered) that can be used for troubleshooting. In addition to this the self-diagnostic routines is also designed to drive transmitter current output outside of the normal saturation values in case a fault mode is detected. The transmitter will drive its current 4/20mA output low (down) or high (up) based on the position of the failure mode alarm jumper(or DIP switch) configured in line with NAMUR requirements. See Table 3.1 for available Current Output values.

[Table 3-1 Standard Alarm and Saturation Value]

Level	4~20mA Saturation	4~20mA Alarm
Low/Down	3.9 mA	≤ 3.75 mA
High/Up	20.8 mA	≥ 21.75 mA

Note: When connecting multiple transmitters in HART® multidrop mode the current output is automatically parked at 4mA. In such installations Fail Mode Alarm on Current output is automatically disabled, however error indication is still available via digital HART® communication as a Status Flag.

APT3100

3.4.2. <Fail Mode Selection DIP Switch on CPU Module >

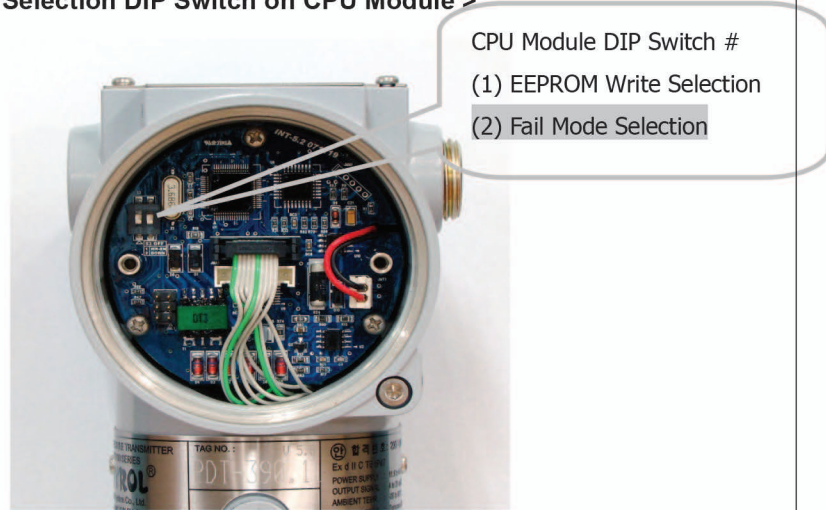
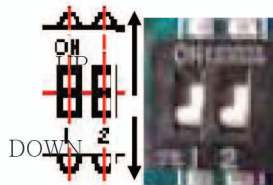

Figure 3-2. Fail Mode Selection DIP Switch location on CPU Board

Note: Use DIP switch (2) on right shown in Fig 3-4 for Fail Mode Selection. DIP Switch (1) on Left on Fig 3-4 is for Write Enable/Disable explained in Chapter 3.5 below.

DIP SWITCH SETTINGS (Fig 3.4)



DIP (2) = Fail Mode(Alarm)

DOWN : FAIL LOW

UP : FAIL HIGH

3-5. EEPROM-Write Enable/Disable Mode Switch

APT 3100 includes an EEPROM (Electrically Erasable Programmable Read Only Memory) that allows saving and restoring various configuration data within the transmitter on power failure. To lock configuration and protect changes to stored configuration data one can use a HHC and or external HART® enabled PC device to enable a software lock feature under Status menu. Optionally for security lock on hardware side there is a Write-Protect Mode DIP Switch(1) on the Main CPU Module placed right next to the Fail Safe Mode switch (2). If you push DIP switch to UP you can lock out users from making any changes to

APT3100

configuration data through push buttons and/or remote HHC already saved in the EEPROM. Alternatively when you push DIP Switch(1) to DOWN you can allow changes made to configuration data in EEPROM. Default state from factory (including with NO Jumpers) installed is EN (enable configuration changes).

CPU Module DIP Switch #
(1) EEPROM Write Selection
(2) Fail Mode Selection

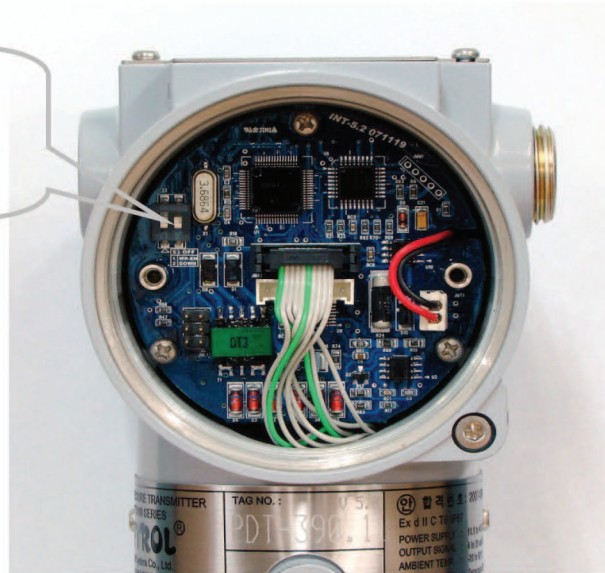
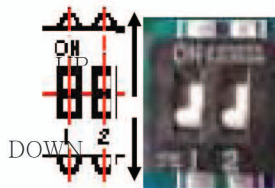

Figure 3-3. CPU Module EEPROM-Write Selection Jumper Switch location

Note: Use DIP Switch (1) shown on Left in Fig 3-4 it is for Write Enable/Disable selection. DIP switch (1) shown on right in Fig 3-4 is for Fail Mode Selection as explained in earlier Chapter 3.4.

CPU BOARD DIP SWITCH SETTINGS (Fig 3-4)



DIP(1) = WR_EN (EEPROM Write Enable)

DOWN : ENABLE CONFIGURATION CHANGES

UP : DISABLE /LOCK CONFIGURATION CHANGES

3.5.1 Security

To quickly summarize there are three options available to implement configuration security lock out within the APT 3100. These include:

- (1) DIP settings on CPU Board
- (2) Software enable/disable on Write function using HHT or HART® PC.
- (3) Physically removing Zero and Span Magnetic Buttons from Transmitter thereby restricting local access to pushbutton menus. This option will still allow changes via a remote HHT or HART enabled configurator.

APT3100

3.5.2 Zero and Span Magnetic Push Buttons

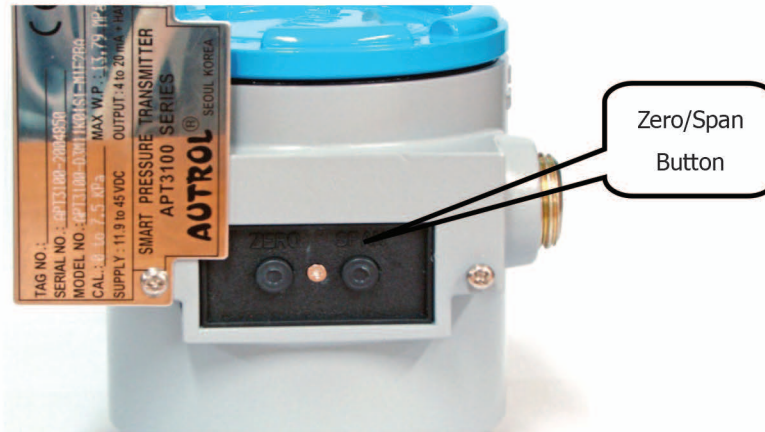

[Figure 3.5.2 Transmitter Zero/Span configuration Buttons]

To access pushbutton please remove top nameplate to expose the magnetic style push buttons labeled zero/span. To disable please unscrew and remove these push button. As these are magnetic style this will not compromise the explosion proof integrity of housing. Access to push buttons is allowed in a hazardous area without disconnecting power to the transmitter.

3.6 Configuration of Alarm and Security Jumper Procedures

To change Jumper/DIP switch position in field:

- (1) If transmitter is already wired and installed, cutoff power.
- (2) Open the housing front side covers. **Warning:** In hazardous areas DO NOT open the covers of Transmitter when power is energized as this can create a potential dangerous situation. Always kill power and De-energize the transmitter prior to opening front OR back covers in a hazardous location.
- (3) Adjust required jumper/DIP position as detailed in section 3.4 & 3.5 above.
- (4) Close the housing covers. You must fully engage all cover threads to ensure compliance to explosion proof requirements

3.7 Configuration using Zero and Span Push Buttons

The local push button allows for local configuration of basic parameters of a transmitter in absence of a HHT or external HART-enabled configurators. To access push button release screw located on Top Name Plate (right side only) located in the upper part of transmitter and slide Name Plate anti-clockwise (slightly until Zero/Span Button is visible and fully accessible as shown in figure 3-5.2.

Single operation of individual buttons (labeled Zero/Span respectively) will initiate a zero/span configuration process as found in conventional transmitters requiring an external pressure source. However as these are smart transmitters most configuration functions such as Zero Trim, Zero adjustment, selecting units, re-ranging (or setting URL/LRL), damping time, display resolution, LCD preference etc can be done without any external pressure source or HHT. Menu access to these smart functions is controlled by specific key strokes outlined in detail in this section. Please read this section carefully prior to operating these buttons.

APT3100

**** FOR CURRENT 7.X FIRMWARE PLEASE REFER TO ATTACHED ADDENDUM -A FOR THE LATEST MENU TREE.

➤ IMPORTANT TIP ON PUSH BUTTON KEYSTROKES

One legit Push Button Keystroke is acknowledged when button(s) are pressed 3 seconds followed by quick (1 second) release immediately after a change in value on display is registered. If not done correctly or by pressing down on push buttons for extended periods even after display value has changed will register as an illegal key sequence and revert user back to measurement mode with error message { BT Error} on display. This Button Error indicates an incorrect push button sequence is registered and will require user to restart from beginning.

After 30 seconds inactivity the automatic time out feature will default user back to normal measurement mode with a "BT-Err" message on display.

First time users should familiarize themselves with legit push button press/release timings and key sequence to avoid repeated "BT Error" messages.

3.7.1: Setting URL/LRL using external pressure source:** Zero/Span configuration process by using either Zero Or Span Button provided on the transmitter & an external pressure source is defined as follows:

- a) **Zero (or LRL) Calibration:** Sets the current process value for Lower Range Value (4 mA). Apply required LRL pressure for 4mA (zero) setting for over 10 seconds to transmitter input and push "Zero" Button over 5 seconds. When LCD displays shows "Zero" release finger from the button.
 - Once you are certain the input pressure for LRL value is stabilized push down on the "zero" button again until display show "-ZE-" in LCD window. Release button and allow 2~3 seconds for transmitter to calibrate the LRL value (applied as PV input).
 - If Zero Procedure was incorrectly performed display will show "ZR-Er" error code* indicating failure and possible LRL setting out of sensor range capabilities.
- b) **Span (or URL) Calibration:** Sets the current process value for Upper Range Value (20 mA). Apply required URL pressure for 20mA (span) setting for over 10 seconds to transmitter input and push "Span" Button over 5 seconds. When LCD display shows "Span" release finger from the button.
 - Once you are certain the input pressure applied is stable push the "span" button again until display show "-SP-" in LCD window.
 - If Span calibration is incorrect display will prompt failure by displaying "SPEr" error code* indicating failure and possible URL setting out of sensor range capabilities.

*Please refer to Appendix 1 for the button error and LCD display message

** For Reranging (URL/LRL) option without using external pressure source please refer to Section 3.8

3.7.2: Advance Configuration Via Push Button.

The advanced "smart" functions which can be initiated using ZERO / SPAN Buttons are shown below. This includes re-ranging of transmitters (Set URL/LRL) without an external pressure source.

To access advanced configuration and enter programming menu press **both** (Zero + Span) buttons simultaneously for 5 seconds. When display reads "Menu" release both push buttons immediately. This will put user into top of main programming menu indicated by message "1-TRIM" on display. To navigate through Main Menu and /or Sub-Menus:-

- (1) Use (Zero) Button to scroll down a menu (or sub-menu if active). Example Pressing/Release (Zero) to scroll down from Main Menu 1-Trim> 2-Setup > 3-LCD >1-Trim > 2-Setup etc. Or from an active sub-menu press/release (zero) to scroll down within a sub menu example 21-Units> 22-URL > 23-LRL > 24-Damping > 21-Units > 22-URL etc.
- (2) Use (Span) button to enter into a specific Sub Menu or data input function.

APT3100

Example Pressing (Span) button from Main Menu<1-TRIM> will put user into Submenu“11>Zero Trim”. Releasing and Pressing (Span) button again will initiate Zero Trim configuration OR Release and Pressing (Zero) button instead will increment user down to submenu “12>Zero ADJ”

(3)Within an active sub-menu use of (Span) button also acts as an <enter> key to allow user to save changes and exit programming mode.

(4)For moving back to previous menu press (Zero+Span) button together. During numeric value entry mode use (Zero+Span) button together to save numeric data inputted and exit from programming menu. See 3.7.3 below.

➤ IMPORTANT TIP ON PUSH BUTTON KEYSTROKE

One legit Push Button Keystroke is acknowledged when button(s) are pressed 3 seconds followed by quick (1 second) release immediately after a change in value on display is registered. If not done correctly or by pressing down on push buttons for extended periods even after display value has changed will register as an illegal key sequence and revert user back to measurement mode with error message { BT Error} on display. This Button Error indicates an incorrect push button sequence is registered and will require user to restart from beginning.

After 30 seconds inactivity the automatic time out feature will default user back to normal measurement mode with a “BT-Err” message on display.

Full Programming Menu flow chart is shown below in Fig 3.5

[Fig 3.5 Menu Tree FOR 6.X ONLY *]**

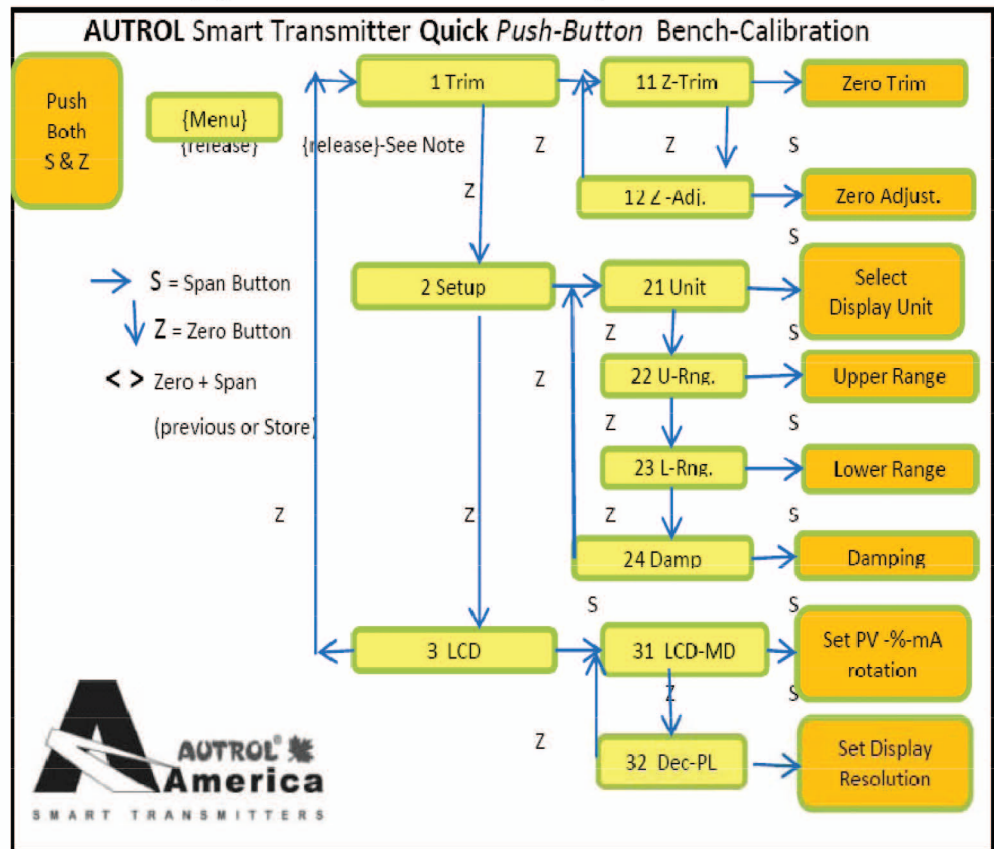

******FOR CURRENT 7.X FIRMWARE PLEASE
REFER TO ATTACHED ADDENDUM -A
FOR THE LATEST MENU TREE.**

APT3100

****FOR CURRENT 7.X FIRMWARE PLEASE
REFER TO ATTACHED ADDENDUM -A
FOR THE LATEST MENU TREE.

3.7.3 STEPS TO INPUT NUMERIC DATA VALUE: Specific functions that need users to input a numerical value are found under sub-menu:

- 12 Zero Adjustment,
- 22 Change Upper Range Value,
- 23 Change Lower Range Value,
- 24 Damping Second

First time users should familiarize themselves with numeric value input sequence prior to accessing above menus. Due to limited flexibility with only 2 push button available for configuration, it is not possible to directly input numeric values within these sub-menus. Instead the correct sequence requires user to first set an increment (10x) rate e.g. 0.01, 0.1, 1.0, 10, 100, 1000 etc and then proceed with changing numeric value by the set rate increment.

For example, to input a numeric value as "3810" from existing displayed value of "0000":

- >First Set increment rate as "1000"
- >Increase display "0000" value 3 times in steps of 1000 till it reads "3000"
- >Then set increment rate again as "100"
- >Increase 8 times in steps of 100 till display reads "3800"
- >Set increment rate again as 10
- >Increase 1 time for a step change of 10 till display reads 3810.

3.7.3.1 Following section outlines the push button sequence for facilitating direct numeric value input from following sub-menus :

"12 Zero Adjustment", "22 Change Upper Range Value",
"23 Change Lower Range Value" and "24 Damping".

When activating these sub-menus (by pushing down & releasing (span) button from within its active menu) the display will automatically prompt for "SEL INC" message. From here:

- a) To select an increment rate push down on (Zero) button when "Set Inc" Message is displayed on LCD sub-menu. Release (Zero) button when display value changes. Each subsequent (Zero) push-release key stroke will shift display decimal point to left. Example when display shows "Sel Inc" 0.01. Subsequently for every push-release keystroke of (Zero) button the display will cycle from >0.1>1.0>10 >100>1000>0.1>1.0 etc.
- b) Once desired "Sel Inc" (viz. 0.1, 1, 10, 100 etc) increment rate is set push the (Span) button to accept and enable set numeric "Value" mode. Note when executing (Span) button from "Set Inc" menu the LCD display will typically show the last saved numerical value along with a "VALUE" message on second line indicating that user can now initiate changes by incrementing or decrementing numeric value.
- c) From within "VALUE" menu pushing down on either (Zero) OR (Span) button (not both) will allow the numeric value to increment (Zero) or decrement (Span) by the "Sel Inc" value selected by user in the previous step (b).
- d) After desired numeric value is displayed, push down on (Zero+Span) buttons together to accept new data inputted and this will bring user back to <Set Inc> menu. Step (a) screen above.
- e) Repeat steps (a) through (c) detailed above until the final numeric value required is displayed under set "Value" Menu.
- f) To store final numeric value to EEPROM push (Zero+Span) button twice to Save and exit. Note pushing Zero+Span once from "VALUE" menu will bring user back to "SET INC" menu step (a). However pressing (Zero+Span) buttons together second time (from "SET INC" menu). Release button when screen shows "INC OK" message after which it will save the last numeric value inputted and bring user back to Measurement Mode.
- g) If successful display will read -DONE- else "BR-ERR" to indicate failure. If display shows "RANGOV" it indicates numerical value inputted is out of spec.

APT3100

****FOR CURRENT 7.X FIRMWARE PLEASE REFER TO ATTACHED ADDENDUM -A FOR THE LATEST MENU TREE.

3.8

Push Button sequence for each Programming Sub-Menu

3.8.1 ZERO TRIM (Sub Menu 11)

- Enter programming menu by pushing both (ZERO+SPAN) button together for 5 seconds. Release buttons when LCD displays Menu and display will automatically change to "1 TRIM" confirming access into programming menu.
- Push (Span) button when "1 TRIM" message appears to enter 11 Z-Trim sub-menu.
- To execute the Zero Trim sub-menu Function push (Span) button when 11 Z-TRIM message appears on LCD display.

(Important Note: make sure Process Input to transmitter is at true zero else this may create an incorrect Zero Offset. If a wrong zero is suspected please execute Zero Trim again ensuring the proper steps & correct Zero PV input is applied to transmitter)

➤ IMPORTANT TIP ON PUSH BUTTON KEYSTROKE

One legit Push Button Keystroke is acknowledged when button(s) are pressed 3 seconds followed by quick (1 second) release immediately after a change in value on display is registered. If not done correctly or by pressing down on push buttons for extended periods even after display value has changed will register as an illegal key sequence and revert user back to measurement mode with error message { BT Error} on display. This Button Error indicates an incorrect push button sequence is registered and will require user to restart from beginning.

After 30 seconds inactivity the automatic time out feature will default user back to normal measurement mode with a "BT-Err" message on display.

3.8.2 ZERO ADJUSTMENT (Sub Menu 12)

- Example used to show changing the PV value as 14

- Enter programming menu by pushing both (ZERO+SPAN) button together for 5 seconds. Release buttons when LCD displays Menu and display will automatically change to "1 TRIM" confirming access into programming menu.
- Push (Span) button when 1 TRIM message appears to enter 11 Z-Trim sub menu. Push (Zero) to change display to Meny 12 Z-ADJ.
- To execute the Zero Adjustment Function push (Span) button when 12 Z-ADJ message appears on LCD display.
- When "SetInc" message appear, push the Zero button repeatedly until 10.0 message appears on LCD. And then push (Span) button to accept and proceed into input "Value" menu.
- When "VALUE" message appears on display, increment forward (span) or decrement backward (zero) to set the LCD value to "10.0". You will note the LCD display will increment or decrement by factor of 10 which is the (SetInc value) sected in previous menu. Once desired base value of "10" is displayed push (Zero+Span) button to accept new value and "Set Inc" message appears upon which release buttons.
- From menu where "Sel Inc" message appears again, change the LCD value to 1.0 by pushing (Zero) button once and then push (Span) button to enter input "VALUE" menu.
- Here push (Span) or (Zero) to increment or decrement by Set Inc (1) until display reads "14" . Push (Zero+Span) button after LCD value is changed to 14.0 and release both button when display reads "SetInc".

APT3100

****FOR CURRENT 7.X FIRMWARE PLEASE REFER TO ATTACHED ADDENDUM -A FOR THE LATEST MENU TREE.

- To save the numeric value of 14 set from previous steps push (Zero+Span) buttons from the "Sellnc" menu to save and exit. Display will show "INC OK" at which point release buttons.
- Display will show "-DONE-" confirming changes has been accepted and then default back into measurement mode. This completes the Zero adjustment configuration.
- If display shows "BT-ERR" instead of -DONE- please repeat all steps once again.
- If display shows "ADJ-U" or "ADJ-L" the inputted numerical value is out of spec for zero adjustment range for the supplied range codes.

➤ IMPORTANT TIP ON PUSH BUTTON KEYSTROKE

One legit Push Button Keystroke is acknowledged when button(s) are pressed 3 seconds followed by quick (1 second) release immediately after a change in value on display is registered. If not done correctly or by pressing down on push buttons for extended periods even after display value has changed will register as an illegal key sequence and revert user back to measurement mode with error message { BT Error} on display. This Button Error indicates an incorrect push button sequence is registered and will require user to restart from beginning.

After 30 seconds inactivity the automatic time out feature will default user back to normal measurement mode with a "BT-Err" message on display.

3.8.3 CHANGE UNITS (Sub-Menu 21) – Example set units to "psig"

- Enter programming menu by pushing both (ZERO+SPAN) button together for 5 seconds. Release buttons when LCD displays Menu and display will automatically change to "1 TRIM" confirming access into programming menu.
- Push (Zero) button when 1 TRIM message appears on LCD. Release button when display changes to 2 SETUP.
- To move into sub menu push (Span) button when 2 SETUP message appears on display. Release button when 21 UNIT message is displayed.
- You are now in the Change Units sub menu. To execute this function push (Span) button when 21 UNIT message appears on display. Release button when display changes to 211 (xxx) where " xxx " is the last units (e.g. bar, kpa, "H2O etc) saved previously.
- Push/release (Zero) button repeatedly to toggle through all available units. When desired "psig" units is displayed save and exit by pushing (Span) button.

➤ IMPORTANT TIP ON PUSH BUTTON KEYSTROKE

One legit Push Button Keystroke is acknowledged when button(s) are pressed 3 seconds followed by quick (1 second) release immediately after a change in value on display is registered. If not done correctly or by pressing down on push buttons for extended periods even after display value has changed will register as an illegal key sequence and revert user back to measurement mode with error message { BT Error} on display. This Button Error indicates an incorrect push button sequence is registered and will require user to restart from beginning.

After 30 seconds inactivity the automatic time out feature will default user back to normal measurement mode with a "BT-Err" message on display.

APT3100

****FOR CURRENT 7.X FIRMWARE PLEASE REFER TO ATTACHED ADDENDUM -A FOR THE LATEST MENU TREE.

3.8.4 CHANGE URL/ Upper Range Value (Sub-Menu 22)

- Enter programming menu by pushing both (ZERO+SPAN) button together for 5 seconds. Release buttons when LCD displays Menu and display will automatically change to "1 TRIM" confirming access into programming menu.
- Push (Zero) button when "1 TRIM" message appears on LCD. Release button when display changes to "2 SETUP".
- To move into sub directory push (Span) button when "2 SETUP" message appears on display. Release button when display changes to "21 UNIT" message.
- Push (Zero) button to move down to sub-menu 22. When display shows "22 U-RNG" release button. You are now in URL sub menu.
- To execute this function push (Span) button when "22 U - RNG" message appears on display. Release button when display changes to 221 (xxxx) where xxxx is last configured URL value saved.
- Follow Set numeric value procedure explained under section 3.7.3 to input desired URL numeric value.

➤ IMPORTANT TIP ON PUSH BUTTON KEYSTROKE

One legit Push Button Keystroke is acknowledged when button(s) are pressed 3 seconds followed by quick (1 second) release immediately after a change in value on display is registered. If not done correctly or by pressing down on push buttons for extended periods even after display value has changed will register as an illegal key sequence and revert user back to measurement mode with error message { BT Error} on display. This Button Error indicates an incorrect push button sequence is registered and will require user to restart from beginning.

After 30 seconds inactivity the automatic time out feature will default user back to normal measurement mode with a "BT-Err" message on display.

3.8.5 CHANGE LRL/ Lower Range Value (Sub-Menu 23)

- Enter programming menu by pushing both (ZERO+SPAN) button together for 5 seconds. Release buttons when LCD displays Menu and display will automatically change to "1 TRIM" confirming access into programming menu.
- Push (Zero) button when "1 TRIM" message appears on LCD. Release button when display changes to "2 SETUP".
- To move into sub directory push (Span) button when "2 SETUP" message appears on display. Release button when 21 UNIT message is displayed.
- Push (Zero) button to move down to sub-menu 22. When display shows "22 U-RNG" release button.
- Push (Zero) button to move down to sub-menu 23. When display shows "23 L-RNG" release button.
- You are now in Change LRL sub menu. To execute this function push (Span) button and release when "231 XXXX" message appears on display. Where xxxx is last configured LRL value saved.
- Follow Set numeric value procedure explained under section 3.7.3.

Note: When setting URL/LRL numeric data please ensure values being inputted fall within the allowed minimum/maximum specifications published for the installed sensor range code. Only if display shows -DONE- will the transmitter update its stored configuration & accept the new values. If out of limits the transmitter will reject values entered and default to previous saved values after displaying a "RANG OVR" error message.

APT3100

****FOR CURRENT 7.X FIRMWARE PLEASE
REFER TO ATTACHED ADDENDUM -A
FOR THE LATEST MENU TREE.

3.8.6 CHANGE Damping Value (Sub-Menu 24)

- Enter programming menu by pushing both (ZERO+SPAN) button together for 5 seconds. Release buttons when LCD displays Menu and display will automatically change to "1 TRIM" confirming access into programming menu.
- Push (Zero) button when "1 TRIM" message appears on LCD. Release button when display changes to "2 SETUP".
- To move into sub directory push (Span) button when "2 SETUP" message appears on display. Release button when 21 UNIT message is displayed.
- Push (Zero) button to move down to sub-menu 22. When display shows "22 U-RNG" release button.
- Push (Zero) button to move down to sub-menu 23. When display shows "23 L-RNG" release button.
- Push (Zero) button to move down to sub-menu 24. When display shows "24 DAMP" release button.
- You are now in Change Damping sub menu. To execute this function push (Span) button when "24-Damping" message appears on display. Release button when display changes to 241 (xxxx) when xxxx is last configured damping value saved.
- Follow Set numeric value procedure explained under section 3.7.3.

➤ IMPORTANT TIP ON PUSH BUTTON KEYSTROKE

One legit Push Button Keystroke is acknowledged when button(s) are pressed 3 seconds followed by quick (1 second) release immediately after a change in value on display is registered. If not done correctly or by pressing down on push buttons for extended periods even after display value has changed will register as an illegal key sequence and revert user back to measurement mode with error message { BT Error} on display. This Button Error indicates an incorrect push button sequence is registered and will require user to restart from beginning.

After 30 seconds inactivity the automatic time out feature will default user back to normal measurement mode with a "BT-Err" message on display.

3.8.7 CHANGE LCD Mode (Cyclic or Fixed Display) (Menu 31)

—Available on Firmware Ver 6.5 higher only. Older Firware skip and see 3.8.8 Change LCD Resolution

- Enter programming menu by pushing both (ZERO+SPAN) button together for 5 seconds. Release buttons when LCD displays Menu and display will automatically change to "1 TRIM" confirming access into programming menu.
- Push (Zero) button when "1 TRIM" message appears on LCD. Release button when display changes to "2 SETUP".
- Push (Zero) button and release when display changes to "3 LCD".
- To move into sub directory push (Span) button after "3 LCD" message appears on display. Release button when 31 LCD-MD message is displayed.
- To enter this sub-menu push (Span) button and release when display changes to 311. Bottom line of display will show current Mode setting e.g. NOR-RO, NOR-PVetc.
- Push (Zero) button to cycle through available mode options and select desired LCD Rotation mode. Options are:
NOR-RO (rotate all PV,%mA), NOR-PV (Fixed PV),
NOR-% (Fixed %), NOR-mA Fixed,
ENG-RO, ENG-PV, ENG-% or ENG-mA.
- Push (Span) to save changes and EXIT programming mode.

APT3100

******FOR CURRENT 7.X FIRMWARE PLEASE REFER TO ATTACHED ADDENDUM -A FOR THE LATEST MENU TREE.**

Important Note: Always select only one of NOR (normal) modes. Though it is possible to set ENG (engineering) modes also from this menu it is not recommended unless specific Engineering mode parameters such as engineering units, High/Low values, Linear/Sq-Root functions etc have been preconfigured either from factory (if specified on your order) or using an external HHC or STT20 PC based configurators when available. With engineering mode enabled users have the added flexibility of configuring LCD display to emulate custom preferences separate from the transmitter current output functions. As such with engineering mode enabled users can program custom units, engineering units for flow, volume totals and level, scale different URL/LRL, linear mode etc independent of those explained in previous sections.

➤ IMPORTANT TIP ON PUSH BUTTON KEYSTROKE

One legit Push Button Keystroke is acknowledged when button(s) are pressed 3 seconds followed by quick (1 second) release immediately after a change in value on display is registered. If not done correctly or by pressing down on push buttons for extended periods even after display value has changed will register as an illegal key sequence and revert user back to measurement mode with error message { BT Error} on display. This Button Error indicates an incorrect push button sequence is registered and will require user to restart from beginning.

After 30 seconds inactivity the automatic time out feature will default user back to normal measurement mode with a "BT-Err" message on display.

3.8.8 CHANGE LCD Resolution (Sub-Menu 32)

—on Firmware Ver 6.5 higher only. Older Firware show this function under Sub-menu 31

- Enter programming menu by pushing both (ZERO+SPAN) button together for 5 seconds. Release buttons when LCD displays Menu and display will automatically change to "1 TRIM" confirming access into programming menu.
- Push (Zero) button when "1 TRIM" message appears on LCD. Release button when display changes to "2 SETUP".
- Push (Zero) button and release when display changes to "3 LCD".
- To move into sub directory push (Span) button after "3 LCD" message appears on display. Release button when 31 LCD-MD message is displayed.
- Push (Zero) button to move down one sub menu and release button when "32- DEC-PL" message is displayed.
- Push (Span) button to execute this sub function. Release button when display changes to 0.0. Note 0.0 will be displayed on first line of LCD. Second line will indicate mode options viz. AUTO, 5-0, 4-1 etc.
- All available resolution modes are listed below in Table

Model	Explanation	Max. Value
AUTO	Auto ranging of display	99999
5-0	None decimal place	99999
4-1	Display one decimal place	9999.9
3-2	Display two decimal place	999.99
2-3	Display three decimal place	99.999
1-4	Display four decimal place	9.9999

- Push (Zero) to cycle through display options i.e. AUTO, 5-0, 4-1, 3-2, 2-3 and 1-4 and once desired resolution is displayed push (Span) to save and exit.

Notes:

- The set resolution will be applicable only for displaying PV (Primary Variable) value and Engineering value if Eng mode is enabled. For mA and % regardless of resolution setting a default 3-2 resolution will be used.
- For basic users select "AUTO" mode. C
- D_OV message will be displayed when PV exceeds its limit values.

APT3100

3.9 Bench Commissioning using STT20

For advance configuration (engineering mode, linear to square root, low flow cut offs, DA Trim) please refer to separate manual for Autrol® STT20 (HART® based PC configuration software) or Autrol® A-CONF321 (HART® based UMPC tablet configurator). In addition to Autrol® configuration software the APT 3100 transmitter can also be configured using external third party Hand Held Terminals such as Emerson 275, 375 to 475 HHC or Meriam 4100/4150 HART® Communicators. Please refer to third party manuals for detailed configuration menus.

3.10 Wiring Connections for External HHT/ Ammeters

APT-3100 Pressure Transmitter can also be commissioned using a HART® enable HHT or any HART® DDL supported PC software either before or after installation. A complete commissioning consists of configuring and/or verifying transmitter configuration data, testing the transmitter, testing the loop, and zero trimming.

For hazardous area installation to avoid exposure of "live" electronic circuits in field it is recommended that all Jumper settings of transmitter (Fail safe, Write disable etc) be done in the shop prior to moving the transmitter on to field installation.

▲ Note Test pins can be used to connect an Ampere meter for measuring output current without disconnecting loop connections OR for connecting a remote indicator. You cannot initiate HART® digital communication if connecting a HHT directly across "TEST" pins. Use terminals marked communication for connecting an external HART® MASTER. You must ensure a minimum of 250~550 ohm resistance in Current Loop for any HART® Communication or PC Configurator to work. If needed connect a 250 ohm resistor in loop to enable digital communications. Also for correct operation of a 4~20 mA loop required power supply (11.9 V ~ 45 Vdc) must be provided at supply inputs marked (+) and (-).

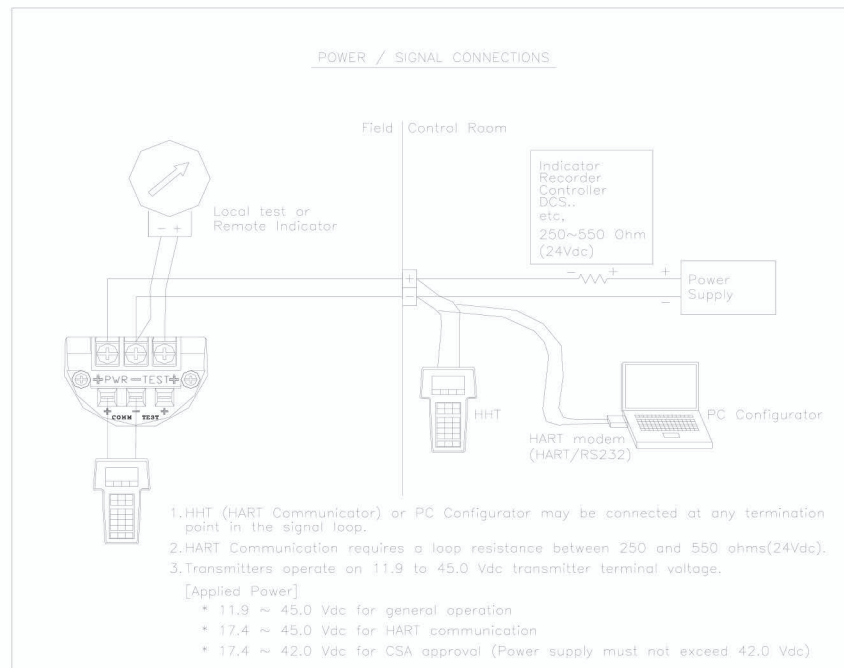

[Figure 3-5 Connection the transmitter to HHT]

APT3100**Chapter 4 Installation****4.1 Overview**

The information in this chapter 4 covers installation considerations. Dimensional drawings for Model APT-3100 variation and mounting configuration are also included in this chapter.

4.2 Safety Message

Procedures and instructions in this chapter may require special precautions to ensure safety of the personnel performing these operations. Information that raises potential safety issues is indicated by a warning symbol (▲). Refer to the following safety messages before performing any operation preceded by this symbol.

4.3 Warning**▲ Warning**

Explosion can result in death or serious injury:

- ◆ Do not remove the transmitter covers in hazardous locations when the circuit is live.
- ◆ Transmitter covers must be fully engaged to meet explosionproof approval requirements.

▲ Warning

Electrical shock can result in death or serious injury. If you install transmitter around a high voltage environment e.g. power lines there may be a very high likelihood of high voltages induced on to the signal lines.

- ◆ Avoid direct contact with the signal leads and terminals to avoid potential electricution .

▲ Warning

Process leaks can cause death or serious injury:

- ◆ Install and tighten before applying pressure . Inspect regularly for process leaks.

▲ Warning

Electrical can result in death serious injury:

- ◆ Only qualified & trained personnels should be allowed to operate these transmitter.

▲ Warning

- ◆ Instrument installed in the process is under pressure. Never loosen or tighten the flange bolts as it may cause leakage of process fluid.

- ◆ If the process fluid may be toxic or otherwise harmful, take appropriate care to avoid contactand/or exposure to direct vapors even after dismantling the instrument from process line for maintenance.

APT3100

4.4 Commissioning on the bench with Hand-Held Terminal

Use of a HHT is possible before or after field installation. However, as a good engineering practice it is recommended to first familiarize with available functions, before installation you have pre-commissioning done on the bench before installing the transmitters in field. In line with good engineering practices please follow the flow chart[®] outlined below.

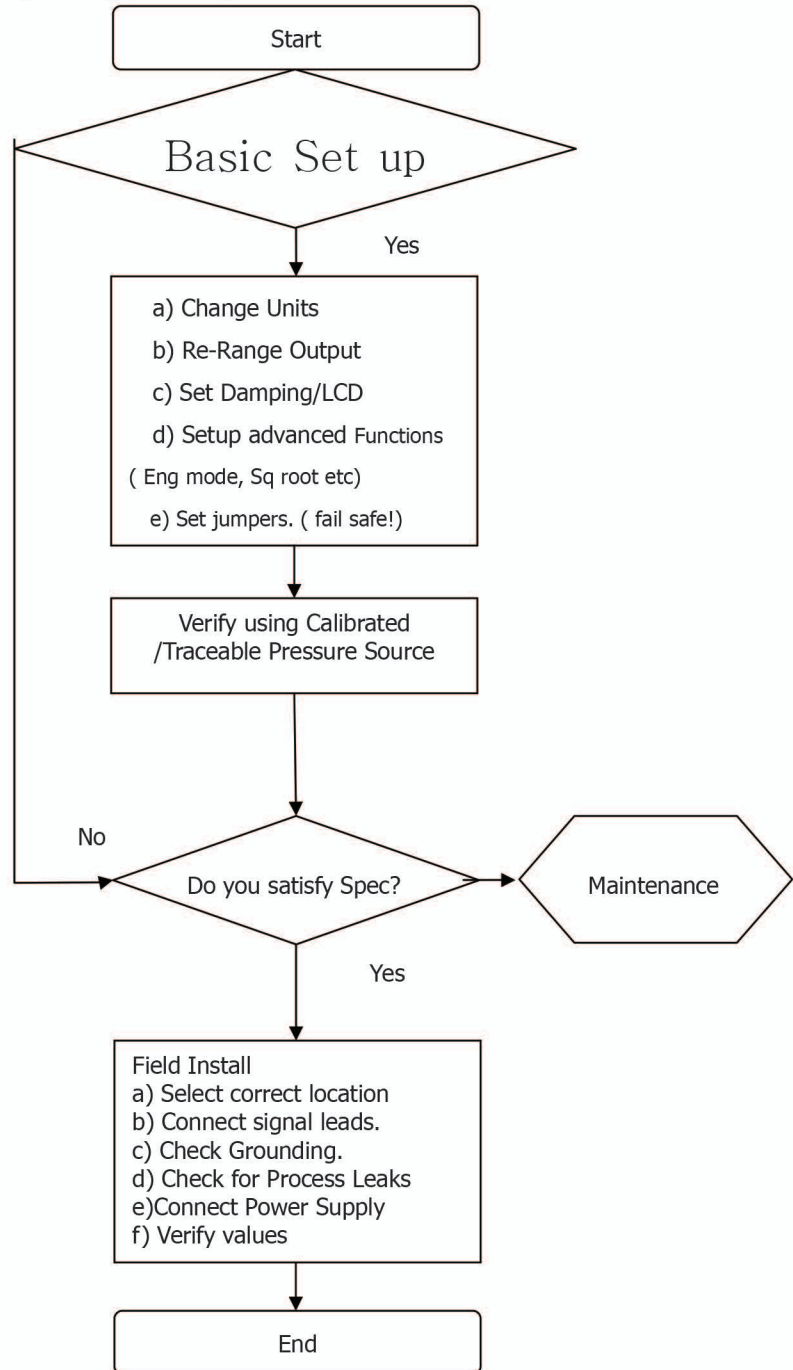

[Figure 4-1 Commissioning Flow Chart]

APT3100

4.5 General Considerations

This APT 3100 transmitter uses a capacitive pick up. As changes in pressure are accurately detected any zero shift or installation offsets will be transmitted as a pressure change on the 4~20mA analog current output. Hence it is recommended that the transmitter be mounted as close to the process and use short impulse piping when possible to achieve best accuracy. However it is equally important to be mindful of basic requirements including ease of access, safety of personnel, practical field calibration accessibility and a suitable transmitter environment when selecting a mounting location. In general, install the transmitter so as to minimize vibration, shock, and temperature fluctuations.

4.6. Electrical Considerations

The internal of the transmitter housing comprises of two sections. The Front section is for the electronics module (MCU Board and LCD module), and Rear side is for the Terminal Block. On backplane of the Rear Cover a "Field Wiring Diagram" is included for easy identification. This can be accessed by opening the rear housing cover and exposing the Terminal Block inside. Terminal Blocks have polarity cleared marked for Supply, TEST and Communication connections. Please connect Transmitter Power to Supply connections with proper polarity. Hand Held Configurators connect directly to "COMM" pin provided below the Supply connections. Similarly a remote field Indicator or Current Ammeter can connect to "TEST" pins provided. Though transmitter is protected from reverse polarity protection it is recommended not to apply incorrect polarity across TEST pins as it may damage the protection diodes included.

4.6.1 Power Supply

For powering transmitter an external DC voltage between 11.9V~ 45 Volts DC is recommended. The external power supply ripple noise should not be higher than 2%. When calculating loop resistances please include resistance of all devices added in the loop. For IS applications when using an Intrinsic Safety Barrier, please also include resistance of IS barrier into the max loop resistance calculations.

$$\text{Max. Loop Resistance } [\Omega] = (E - 11.9) [\text{Vdc}] / 0.022 [\text{mA}]$$

Here, loop resistance of minimum 250 ~ 550Ω (@24 Vdc) is recommended for HART® communication.

4.7. Wiring

4.7.1 Cautions during Wiring

- (1) Install signal cables away from electrical noise resources like capacitive transformers, motors, power supplies where possible.
- (2) Before wiring pull out the electrical lead connection cap included and replace with appropriate cable glands.
- (3) Please use waterproof sealants on conduit screws. Use of silicon based sealants is recommended when possible.
- (4) Do not run signal lines & power lines in same cable duct to reduce noise on signal lines.
- (5) For explosion-proof transmitters in order to maintain explosion-proof requirements please follow additional local electrical codes and practices where applicable.

APT3100

4.7.2 Selection of Wiring Materials

- (1) Use PVC shielded wire or standard lead line of same class or cable rated for 600V or higher. In order to ensure proper communication use 24 AWG or larger wire specs, and do not exceed 1500 meters.
- (2) Use twisted pair double shielded wires in high electrical noise affected areas.
- (3) For high or lower ambient temperature areas ensure wires or cables installed also meet the operating temperature specs.
- (4) Similar use appropriate insulation in environment with high likelihood of oil, solvent, toxic gas or liquid spills.
- (5) Wiring leads must NOT be soldered to terminal lug. Use the mounting screws included instead to ensure a tight rigid hook up to the terminals.

4.7.3 Wiring Hook ups

Wiring method is following this.

- (1) Open the housing cover indicated "FIELD TERMINAL". NOTE: For hazardous environments do not open the covers when transmitter is powered and circuits are live.
- (2) Connect the power supply in the terminal indicated "+PWR"(left terminal) and "-" power supply in the central terminal. Do NOT connect "+" power supply in "+" terminal of the point indicated "TEST". It will be damage to test diode used to connecting TEST terminal.
- (3) Seal and close unused Conduit Connections to protect transmitters from severe humidity and explosive gases from entering into the terminal box compartment.
- (4) Avoid running Signal Wiring near AC or High Power Lines. In case of ground signal, ground the signal loop's on one side making sure other side is not grounded.
- (5) Ensure loose contacts are eliminated and proper wiring connections are maintained.
- (6) After wiring replace transmitter cover. In case of explosion proof areas, you must to satisfy all requirements to maintain certification requirements.
- (7) Do not supply high voltage AC power into transmitter leads as it can cause permanent damage to transmitter.
- (8) Use surge protectors to protect transmitter from external power surges.
- (9) Ensure you have a 250~600 W Loop Resistor in Current Loop (between Power Supply and Transmitter) for proper HART® Communication. Follow Figure 4-2 below for wiring instructions.

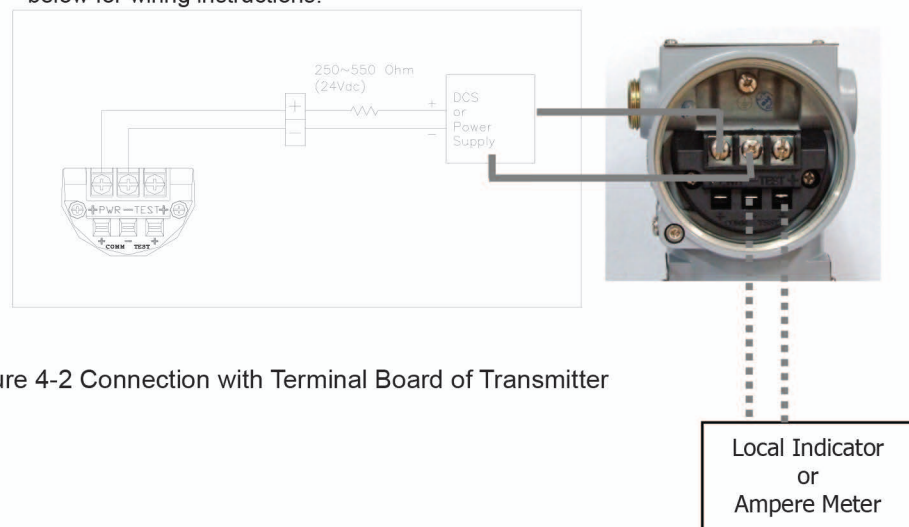

Figure 4-2 Connection with Terminal Board of Transmitter

APT3100

4.7.4 Warning

▲ Warning

Explosion can result in death or serious injury:

- Do not remove the transmitter covers in explosion environments when the circuit is alive.
- Before connecting an external HHTdevice to transmitter in explosive areas, confirm that the configuration device meets appropriate safety regulations.
- Both transmitter covers must be fully engaged to meet explosion proof requirements

A. Loop Configuration

AUTROL® Series Transmitters uses a two-wire loop powered system for 4~20mA analog and digital HART® transmission. External DC Power Supply is required for operation of this transmitter loop. The Transmitter and external source connections are as shown below.

(1) Non-Explosion proof / Flameproof Type

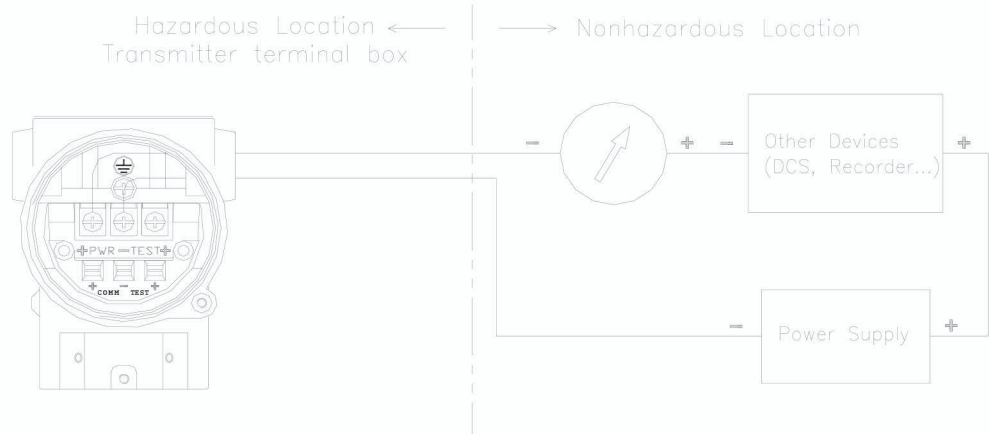

[Figure 4-3 Connection between Transmitter and Power Supply]

(2) Explosionproof Type

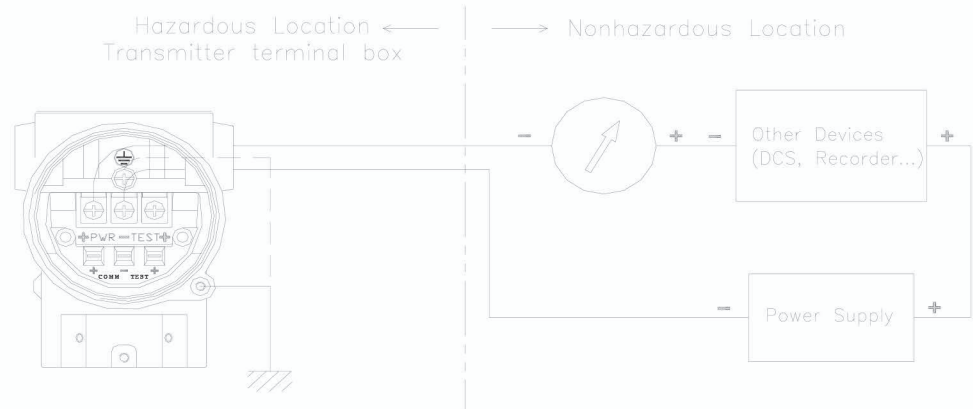

APT3100

(3) Intrinsic Safety Type (IS Barrier in safe are only)

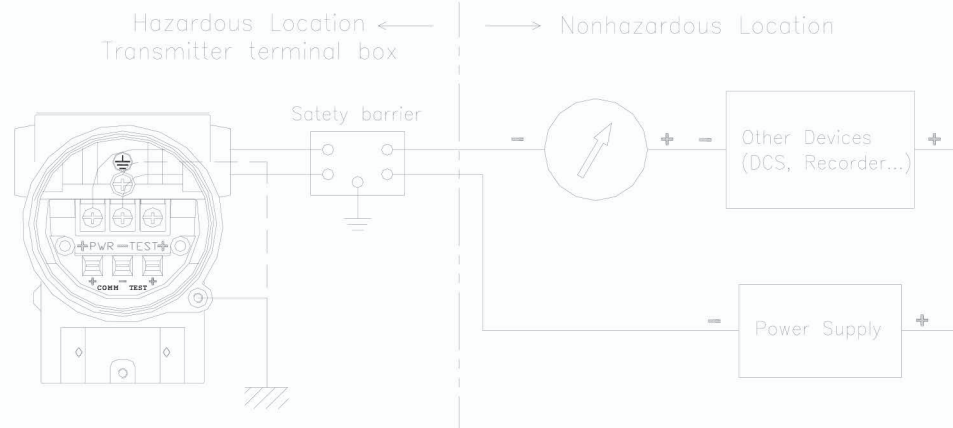

[Figure 4-3 Connection between Transmitter and Power Supply]

B. Wiring Installation

(1) General- Purpose and intrinsically Safe Type Installations

- Use metallic conduit or waterproof cable glands.
- Apply a non-hardening Sealant to the conduit threads to ensure water tight sealing.

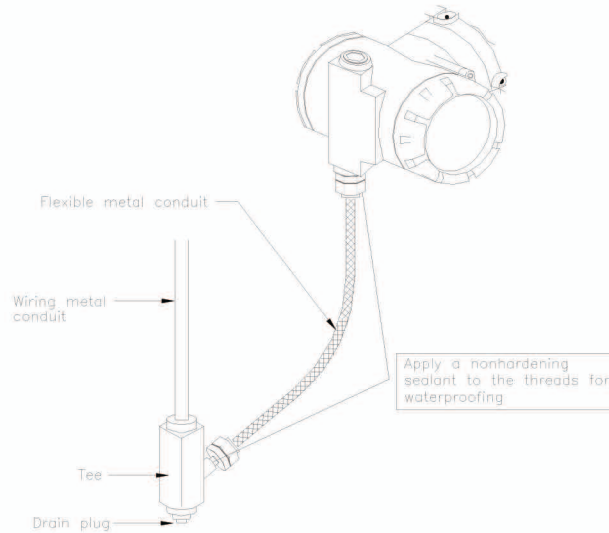

[Figure 4-4a Typical Wiring using Flexible Metal Conduit]

APT3100

- (2) Explosion proof & Flameproof Type (see Figure 4-4b)
- Use only flameproof approved glands as per local regulations.
 - Apply a non-hardening sealant to the conduit threads.
 - Mount explosion proof gland glands to the transmitter conduits.
 - Screw the flameproof glands until the O-ring touches the terminal box wiring port (at least 5 full turns), and tighten the lock net.

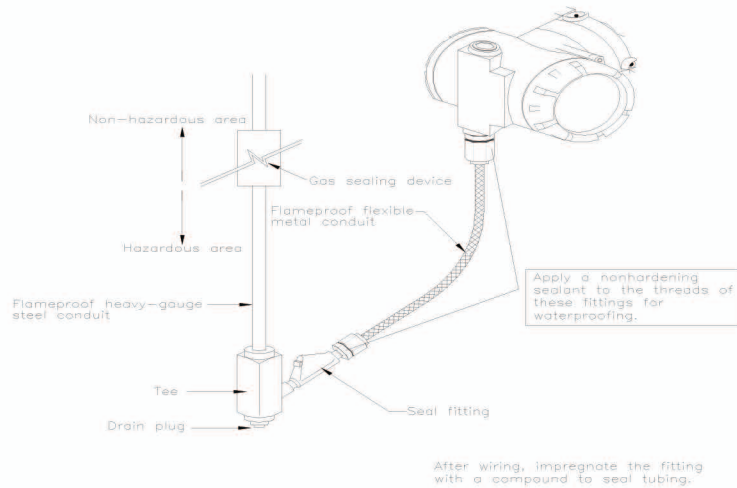

[Figure 4-4b Typical Wiring using Flameproof Packing Adapter]

4.7.5 Grounding

- a. Grounding should satisfy typical requirements (grounding resistance, 10 Ohm or less). Grounding is required below 10 Ohm for explosion proof and intrinsic safety.
- b. [Note] In case of with Built-in Lightning Protector (LP option) grounding should satisfy special requirements of 1 Ohm or less.
- c. There are ground terminal provided on the inside and outside of the terminal box. Either one of these terminals may be used for grounding the transmitters.
- d. Use PVC insulated wire (600V min rated) for grounding.

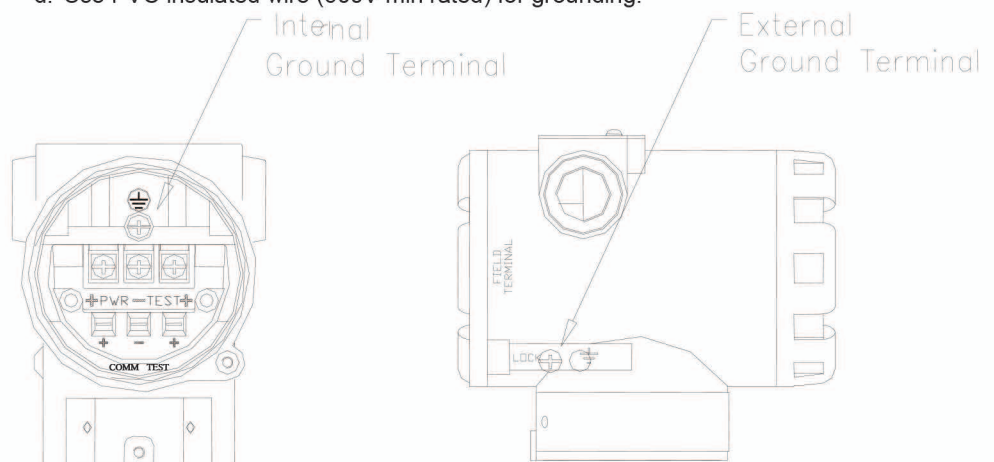

APT3100 Smart Pressure Transmitter
Internal and External Ground Terminal

APT3100

4.7.6 Power Supply Voltage and Load Resistance

When connecting an external load make sure load resistance is within the range noted in the figure below. Note voltages specified must be measured at the transmitter signal terminal input and not at the source. It must meet following requirements:-

- General Standard : 11.9 to 45 Vdc
- HART® Communication : 17.4 to 45 Vdc
- KOSHA Explosion proof: 11.9 to 45 Vdc
- FM/FMc Explosion proof : 17.4 to 42 Vdc max.

Maximum loop current is 22 mA, Hence Max Load resistance R allowed:

$$R = (E - 11.9) / 0.022 \quad (E = \text{Power Supply Voltage})$$

[Note] In case of intrinsically safe transmitters, external load resistance calculated must include safety barrier input resistance.

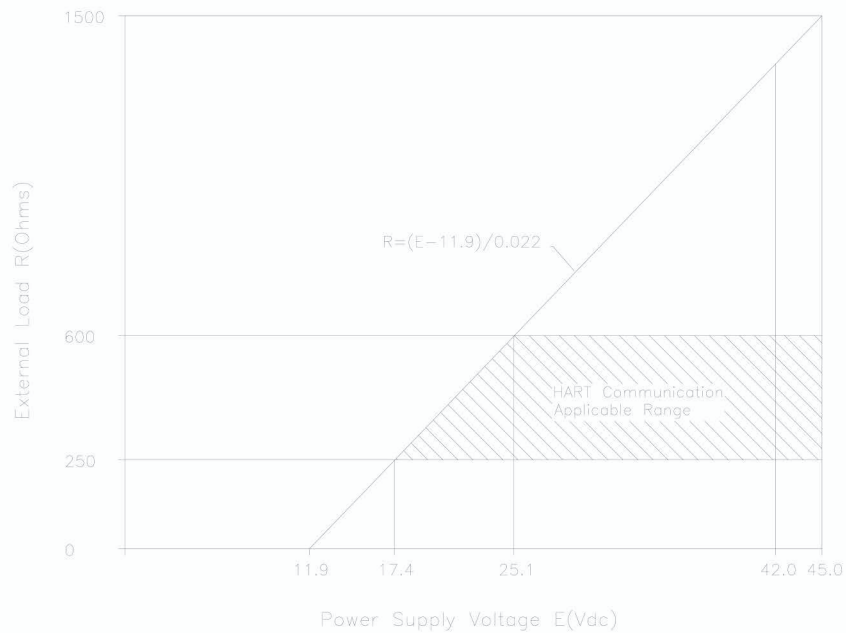

APT3100

4.8 Mechanical Considerations

Figure 4-3 is transmitter dimensional drawings of APT3100. A typical mounting example including dimensional details is shown in Figure 4-6.

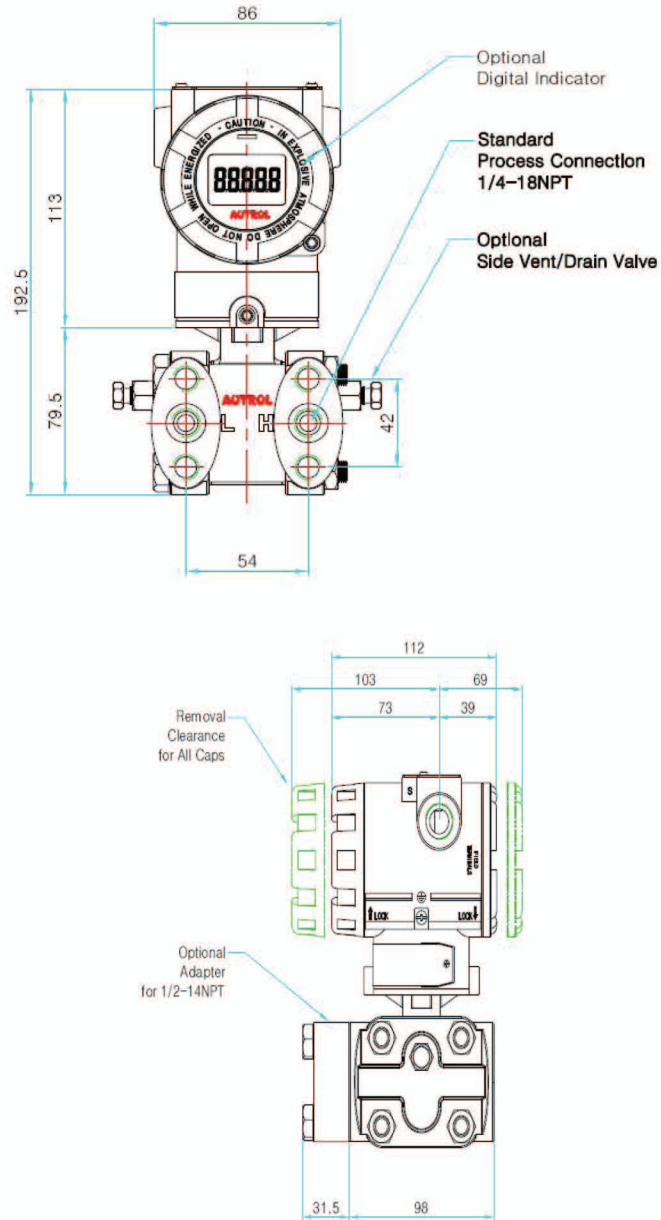
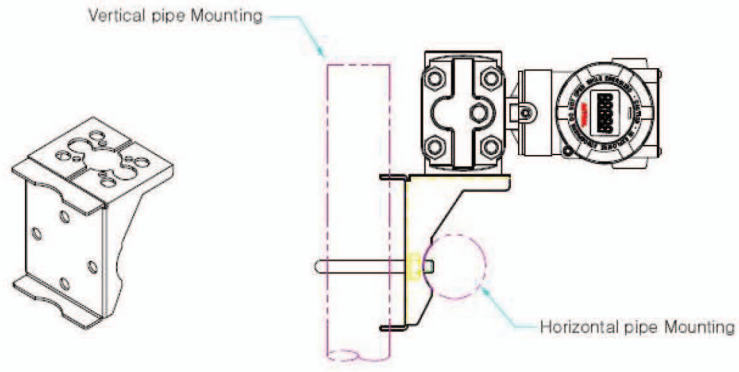
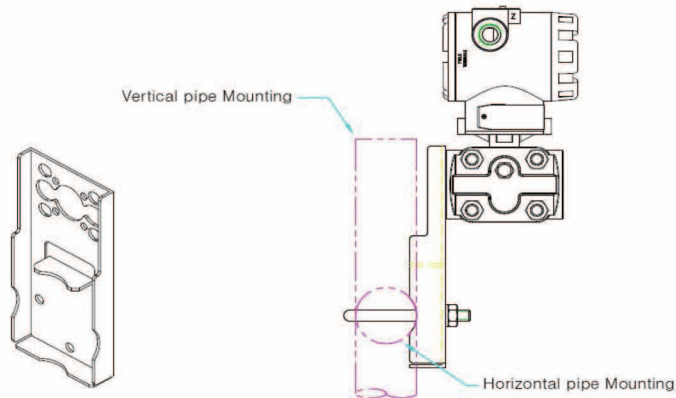

Figure 4-6. Model APT3100 Outline Dimension Drawing

APT3100



Vertical Mounting Type
2" Pipe Mounting Bracket
Model : Angle Type



Horizontal Mounting Type
2" Pipe Mounting Bracket
Model : Flat Type

Figure 4-7. Typical Bracket Mounting

4.8.1 Mounting

During installation provide transmitters with adequate support. In the case of severe vibration, we recommend mounting to a 2" pipe using appropriate mounting bracket available as option. Autrol® offers two styles of mounting brackets in SS. This includes a BA (Angle type) and BF (Flat type). For mounting a 3200 direct mount style a BA type is highly recommended.

APT3100

4.8.2 Transmitter accessibility.

When selecting a suitable location to install the transmitter it may be convenient to also consider following options.

- Ensure adequate clearance is provided for rear cover access & wiring terminals.
- If LCD option is installed provide adequate access for front.
- Housing can be rotated up to 90° clockwise or anticlockwise to provide easy access to front (or rear) of the transmitter. When rotating housing loosen lock nut placed above neck tag and ensure that sensor cable connector are not damaged.
- LCD Module can also be rotated 360 degree if required.

4.9 Environmental Considerations

4.9.1 Effect of Ambient Temperature

Transmitter is recommended for use within -40C to 80C operating ambient temperature range. Recommended installation for continuous operation is -20C to 60C with appropriate heat tracing or insulation provided if installing outside of these limits for extended periods.

4.9.2 Toxic/High Humidity considerations

Housing of APT smart transmitters is protected from direct exposure to moisture or toxic materials provided front and rear covers are engaged fully with appropriate O-rings included. Electronic circuits are separated from terminal side; however it must be protected from moisture ingress entering housing through conduit lines. To avoid moisture build up use appropriate water tight sealants on conduits entries and ensure correct positioning of conduit pipe to avoid condensation buildup from occurring inside the terminal housing.

4.9.3 Installation in Hazardous locations

Transmitter Housing is designed to meet explosion-proof protection requirements. When installing transmitter inside of a hazardous classified area please ensure all required explosion-proof installation & wiring requirements outside of the transmitter as stated by local regulatory bodies are also complied with.

APT3100**Chapter 5 On-line Operation****5.1 Overview**

This chapter describes configuration functions of an Autrol® APT series SMART Pressure Transmitter. Transmitter can be configured in either On-Line or Off-Line mode. In On-Line Configuration Mode, you must connect through an external HHT (Hand Held Terminal) or PC configuration tool supporting HART® DDL technologies. When connecting in Multi-drop mode ensure each device on the HART® bus is provided with a unique HART® device ID for identification.

5.2.2 Multidrop Mode

In the case of multidrop mode where Current Loop is set at 4ma the current Loop must be set to passive mode. This is set automatically when changing the HART® device ID to a numeric value 1 to 15 (except 0).

5.2 Safety Message

For safety of operator please pay specific attention to safety note identified under Warning symbol (▲).

▲ Warning

Explosion can result in death or serious injury:

- Do not remove the transmitter covers in hazardous areas when the circuit is live.
- Before connecting HHT in a classified zone, check that the configuration device connecting to transmitter also complied to required safety regulations.
- Both transmitter covers must be fully engaged to meet explosion-proof certification requirements

5.3 Configuration Data Review

In case transmitter is already installed on site review configuration data to reconfirm it meets the application requirements. This includes verifying suitability of sensor range code, set URL/LRL value and output modes (linear or sq. root).

5.4 Check Output

Transmitter is provided with a Loop Test function (accessible only via an HHT) under service/ maintenance menu which can be used to output desired values 4, 8, 12, 16, 20mA for testing current outputs.

5.4.1 Process Variable

The APT-3100 SMART Pressure Transmitter measures two variables. Primary Variable is always the process pressure measured and SV (Secondary Variable) is the temperature. Note temperature measured is used strictly for internal compensation . Only PV value can be assigned to current output on a 4~20mA loop. However in digital mode both PV and SV can be read through a compatible HART® communicating device.

APT3100

5.5 Basic Setup

This involves configuring minimal settings required to operate transmitter correctly.

5.5.1 Select Sensor Range

This value is automatically set from factory based on the Sensor Range code installed on the transmitter. This Range defines the minimum/maximum range limits and span settings for installed sensor which should not be exceeded for normal operation or during Re-ranging or Zero/Span configuration.

5.5.2 Set Output Units (Measurement)

Select required measurement units e.g. kPa, kg/cm², bar, psi, mmH₂O etc. Note This is different to Engineering mode unit's as settings configured under this menu affect only the transmitter current 4/20mA output configuration. In Normal LCD mode these units are indicated on LCD module (if fitted).

5.5.3 Rerange

Set the URL and LRL for the 4~20mA analog output. As sensor is fully characterized over the entire published range under 5.5.1 users can re-range within specified limits without requiring an external pressure source input.

5.6 Detailed Setup

5.6.1 Set Fail Safe Mode

Sets failure mode (fail down or fail up) for 4/20mA outputs in case of an error or malfunction detected automatically during self diagnostic routine included within the transmitter.

5.6.2 Set Damping Time

Determine the appropriate damping setting based on the required response time, signal

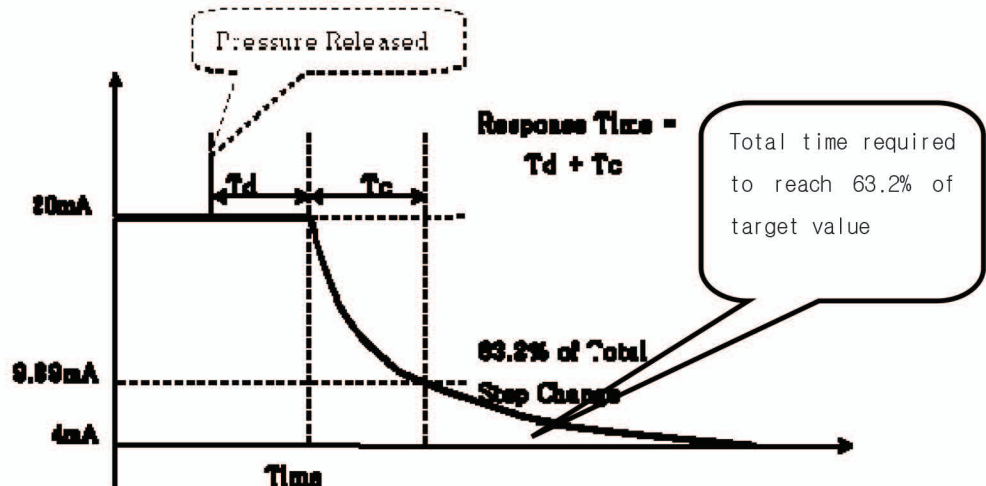

stability, and other requirements of the loop dynamics of your system. The default damping value is 1.0 seconds, and can be reset to damping values between 0 and 60 seconds.

[Graph illustrating Damping /Response time features]

APT3100

5.6.3 Set LCD Mode

Sets LCD display mode (if installed option M1). Can be set for NORMAL or ENGINEERING MODE. If Engineering mode is enabled LCD Display will be tagged as Engg on top center and in this mode LCD display can be independently configured from the actual measured PV settings & current output settings based on freely configurable engineering units (flow, level, total), linear or sq-root mode and rescaled Hi-Lo limits for the PV. Engineering mode can be used as a secondary process indicator that follows the 4/20mA output configured but independently scaled and set as a standalone process indicator.

5.7 Tag Information set up

5.7.1 Set Tag

Set tag information to uniquely classify transmitter. Tag information is limited to max of 8 alpha-numeric characters. For additional description use Set Message option under 5.7.2.

5.7.2 Set Messages

Here user can define additional description limited to max of 8 alpha-numeric characters. This information is saved in the EEPROM of transmitter.

5.8 Diagnostic Services

5.8.1 Loop Test

The Loop Test verifies the output of the transmitter, the integrity of the loop, and the operations of any recorders or similar receiver devices installed in the current loop. Perform the following procedure for a loop test.

- Connect a reference meter to the transmitter either in series in the loop or across TEST pins.
- Select the Loop Test menu on the HHT and initiate Loop Test function.
- Select desired output current (4mA/8mA/16mA/20mA/etc.)
- Compare with readings on reference meter. If this matches then the transmitter and the loop are configured and functioning properly. If the readings do not match, then check to see if the reference meter is connected correctly, or check for faulty wiring, or the transmitter may require an output D/A trim, or the reference meter may be not be calibrated correctly.

5.9 Calibration

Re-Ranging scales the upper and lower limits of transmitter outputs and does not affect the stored calibration data of the transmitter. On the other hand a Sensor Trim function can be used to tune/modify the stored calibration.

It is important to keep in mind that smart transmitters operate differently from conventional analog transmitter. A Smart transmitter uses a microprocessor that contains information about the sensor's specific characteristics in response to pressure and temperature inputs which is what is used for calculating final PV (Process Variable). These calibration curves are performed under traceable laboratory standards and stringent quality control parameters. Changing factory calibration data is advisable only if it is necessary to correct transmitter offsets and only when checking against a traceable calibration source which is at least five times more accurate than the transmitter under test.

As such a Sensor trim and Output Re-range function differ. Reranging sets the transmitter analog output to the selected upper and lower range points and can be done with or

APT3100

without an applied pressure. Reranging does not change the factory characterization curve stored in the microprocessor. Sensor trimming requires an accurate pressure input and adds additional compensation that adjusts the position of the factory characterization curve to optimize transmitter performance over a specific pressure range.

5.9.1 Sensor Trim

The Sensor trim function adjusts the A/D signal conversion within the transmitter sensor electronics and determines how it digitally interprets any pressure changes applied to the sensor inputs. It is highly recommended to perform a sensor trim when first commissioning the transmitter on site. There are three ways to trim the sensor: Sensor zero trim, full trim and zero adjustment.

Sensor zero trim is a one-point adjustment typically used to compensate for the mounting position.

Two point trim is a full sensor trim, in which two accurate pressures with difference within the published sensor span specifications for the specific range codes are applied (equal to or greater than the range values), and the output is set to linear. You should always adjust the low trim value first to establish the correct offset.

Zero adjustment allows user to add a pre-defined offset (other than zero) to measured PV that may be required on certain applications such as Level measurements to compensate for nozzle placements.

5.9.2 DA (Digital to Analog) Trim

The Sensor Trim functions adjust the calibration values of the PV applied to sensor (on input side only), however a D/A trim adjusts sensor input to match the 4~20mA current output. When executing a D/A trim the current output can be adjusted minutely to match desired current values outputted from the transmitter. To perform a D/A Trim a precise and traceable reference current meter is required to be connected on the output loop. When performing a D/A trim avoid using TEST pin and try to install reference meter directly in series in output loop to eliminate any undesirable offsets. Here again make sure that reference meter used for D/A trim is 5 times more accurate than published accuracy specs of the transmitter. When performing a D/A trim it is recommended to do a minimum of two points i.e. trim at (4mA) and (20mA). It may however be necessary to perform repeated trims at both 4/20mA to achieve optimum results.

5.10 Advance Set Up:

(Needs a HART enabled HHT and /or PC configurators)

5.10.1 Output Mode

The transmitters can be set to output its 4/20mA signal in linear or Square Root. Square Root mode may be desirable configuration when installing an APT 3100D for flow measurement.

In Engineering mode (when enabled) users have added flexibility of enabling square root mode only for local display purposed on LCD and retain a linear 4/20mA current output for a remote totalize or DCS /PLC control system. Both mode configurations can be enabled on all units as standard except these advance features require an external HART enabled configurators and supported DDL files. Please contact a local Autrol office for additional details.

5.10.1 MASTER RESET

Allows rebooting of transmitter in case of system failure or corrupt firmware. This software feature emulates a hard power reset sequence which would have required physical disconnection of power supplied to input supply terminals.

APT3100**Chapter 6 Maintenance****6.1 Overview**

This chapter describes diagnostic and maintenance functions for the APT series transmitters.

6.2 Safety Message

When operation, it requires specially notice for the safety of operator. Information that raises potential safety issues is indicated by a warning symbol (▲). Refer to the following

6.2.1 Warning**▲ Warning**

Explosion can result in death or serious injury:

- ◆ Do not remove the transmitter covers in hazardous locations when the circuit is live.
- ◆ Transmitter covers must be fully engaged to meet explosionproof approval requirements.

▲ Warning

Electrical shock can result in death or serious injury. If you install transmitter around a high voltage environment e.g. power lines there may be a very high likelihood of high voltages induced on to the signal lines.

- ◆ Avoid direct contact with the signal leads and terminals to avoid potential electricution .

▲ Warning

Process leaks can cause death or serious injury:

- ◆ Install and tighten before applying pressure . Inspect regularly for process leaks.

▲ Warning

Electrical can result in death serious injury:

- ◆ Only qualified & trained personnels should be allowed to operate these transmitter.

▲ Warning

◆ Instrument installed in the process is under presure. Never loosen or tighten the flange bolts as it may cause leakage of process fluid.

◆ If the process fluid may be toxic or otherwise harmful, take appropriate care to avoid contactand/or exposure to direct vapors even after dismounting the instrument from process line for maintenance.

APT3100

6.3 Hardware Diagnostics

If you suspect a malfunction follow Table 6-1 described here to verify that transmitter hardware and process connections are in good working order.

[Table 6-1 Trouble shooting]

Symptom	Potential Source	Corrective Action
Transmitter Does not Communicate With HART® Communicator	Loop Wiring	<ul style="list-style-type: none"> Check for a minimum 250 ohms loop resistance is available for the HHT. Check for adequate voltage to the transmitter at the signal input terminals. This must be greater than 18V for HART® communications. Check for intermittent shorts, open circuits, and multiple grounds.
High Output	Sensor Input Failure	<ul style="list-style-type: none"> Connect HHT and enter the Transmitter test mode to identify the specific sensor failure.
	Loop Wiring	<ul style="list-style-type: none"> Check for loose or defective terminals, interconnecting pins and/or receptacles.
	Power Supply	<ul style="list-style-type: none"> Check the output voltage of the power supply at the transmitter signal input terminals. It should be 11.9 to 45 Vdc.
	Electronics Module	<ul style="list-style-type: none"> Connect HHT and enter the Transmitter test mode to identify module failure. Check the sensor limits to ensure configuration parameters are within the published sensor range.
Erratic Output	Loop Wiring	<ul style="list-style-type: none"> Check the output voltage of the power supply at the transmitter signal input terminals. It should be 11.9 to 45 Vdc. Check for intermittent shorts, open circuits, and multiple grounds. Check for proper polarity at the signal terminals. Check for current value using external ammeter.
	Electronics Module	<ul style="list-style-type: none"> Connect HHT and enter the Transmitter test mode to identify an electronics mode failure.
Low Output or No Output	Sensor Element	<ul style="list-style-type: none"> Connect HHT and enter the Transmitter test mode to identify an electronics mode failure. Check the PV to see if it is out of range.
	Loop Wiring	<ul style="list-style-type: none"> Check for adequate voltage to the transmitter. The transmitter always requires 11.9 ~ 45 Vdc. Check for intermittent shorts, open circuits, and multiple grounds. Check polarity of signal terminal Check the loop impedance.
	Electronics Module	<ul style="list-style-type: none"> Connect HHT and check the sensor limits to ensure calibration adjustments are within the sensor range.

Table 6-1 T

APT3100

6.4 Hardware Maintenance

Autrol® APT series Smart Transmitters have no moving parts and require minimal scheduled maintenance. Transmitters feature modular design for easy maintenance. If you suspect a malfunction, check for an external cause before performing any internal maintenance as discussed in this section. If you must return failed transmitters or parts, first obtain a Return Material Authorization# before sending units back to Autrol® America Inc. for inspection, repair, or replacement.

6.4.1 Test Terminals

The test terminal is clearly marked as TEST on the terminal block behind the rear cover. The test and negative terminals are connected internally via a diode. As long as the voltage across these terminals is kept below the diode threshold voltage, no current passes through the diode. To ensure that there is no leakage current through the diode while making a test reading, or while an indicating meter is connected, the resistance of the test connection or meter should not exceed 10 ohms. A resistance value of 30 ohms will cause an error of approximately 10 percent of reading.

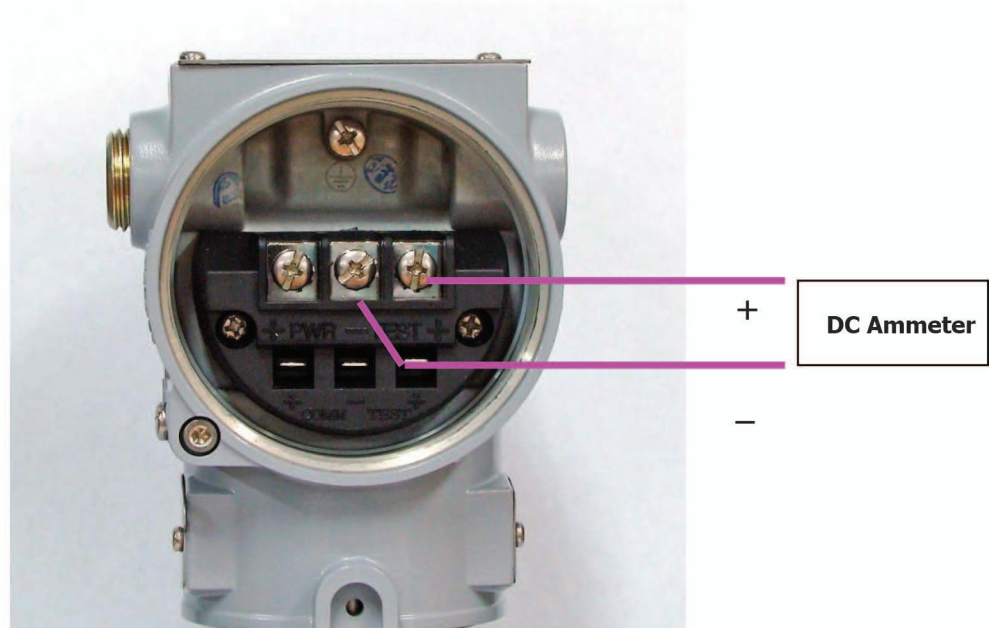

[Figure 6.1 Test Terminals]

APT3100

6.4.2 Disassembling the Electronics Housing

The transmitter is designed with dual-compartment housing; one contains the electronics module, and the other contains all wiring terminals and the communication receptacles.

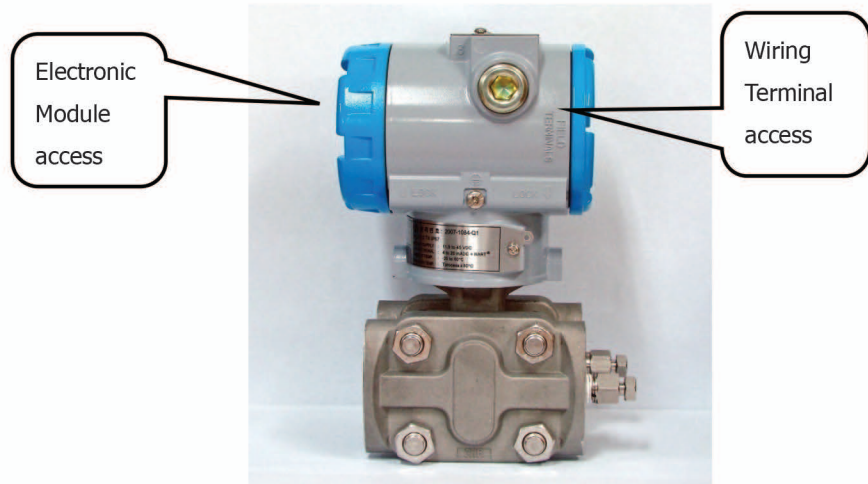

[Figure 6.2 Housing Structure]

6.4.2.1 Disassembling Electronics Module

Use the following procedure to remove the electronics module.

[Note1]:-The electronics module (also referenced as MCU board) uses components meeting MIL specification. The MCU Board comes standard with conformal coating for added protection in tropicalized environments. The MTBF of these modules is greater than 150 years and hence these modules are designed as non-repairable units. If a malfunction does occur the entire unit must be replaced.

1. Disconnect the power to the transmitter. Remove the cover from the electronics side of the transmitter housing (Figure 6.2).
2. Do not remove the instrument cover in explosive atmospheres when the circuit is alive.
3. Remove the LCD meter, if applicable by first disconnecting the screws and then pulling out the LCD module from the plug in connector located behind the module.
4. Remove the two screws that anchor the MCU electronics module to the transmitter housing.
5. Remove the Analog Sensor cable & Power cables from their plug in connectors.
6. Firmly grasp the MCU electronics module and pull it straight out of the housing, taking care not to damage the interconnecting pins.

[Note2]:The transmitter EEPROM-Write Enable and failure mode jumpers are located on the front of the MCU electronics module. When replacing with a new one make sure to duplicate the same jumper settings on the replacement board.

APT3100

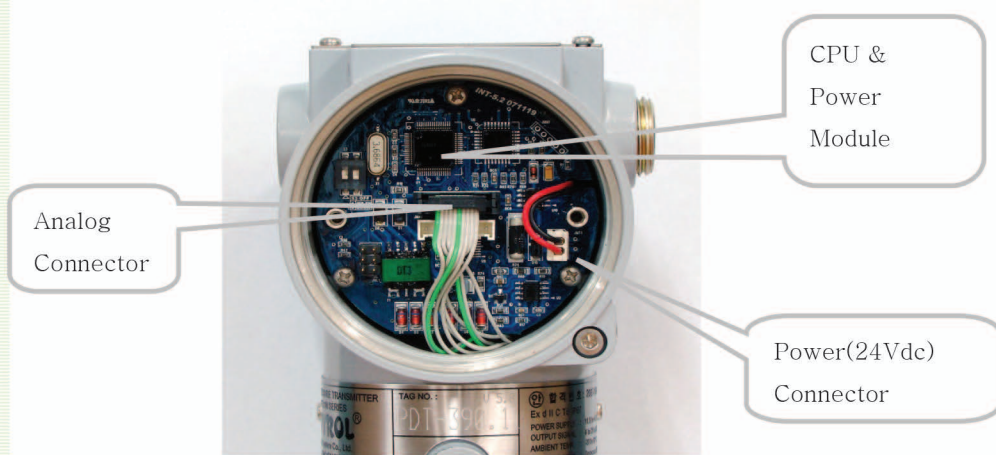

Figure 6.3 Structure of MCU Electronics Module

6.4.2.2 Fail Mode and Jumper Switch of EEPROM-write

Fail-mode and jumper switch of EEPROM-write is located front of electronics module (Refer to Figure 2-2, 2-3)

6.4.3 Assembling the Electronics Housing

Re-assembling procedure is same as follows:-

1. Make sure that Fail-mode and Jumper Switch are set exactly as the MCU board being replaced.
2. Insert electronics module into housing Connect back the cable connectors of analog sensor board & power. Note an improper connection on either connector can cause wrong outputs and/or effect power to the transmitter. Also make sure neither of the connector cables are pinched or twisted between the MCU board and transmitter housing.
3. Anchor MCU module with the 3 screws.
4. Attach LCD module making sure plug in connectors are installed correctly on appropriate mating connectors on the MCU board.
5. Secure LCD module with the screws provided.
6. Close the Front cover of housing. For explosion proof rated transmitters ensure covers are fully engaged with O-Ring seal is securely in place.
7. Power on transmitter and note the start up screen/boot sequence.
8. IF all self checks are completed and found OK the transmitter will enter measurement mode automatically.
9. If any errors same will be displayed on LCD. Follow the troubleshooting guide included in this manual to help identify and correct any fault conditions.

APT3100

Appendix I

APT SMART PRESSURE TRANSMITTER- LCD DISPLAY CODE

Message	Description	Remarks
ADJ-U	Set value outside of upper limits during Zero Adj function.	Check limits
ADJ-L	Set value outside of upper limits during Zero Adj function.	Check limits
ZERO	Initial message when activating Zero push button	Apply zero input
SPAN	Initial message when activating Span push button	Apply span input
BT-ERR	Button input Sequence error.	Check key seq.
P-LOCK	Write Protect Lock on	Check Jumper
ZT-ERR	Setting Limit (10%) Error when Zero Trim	Redo Zero Trim
-TR-	Zero Trim Done	Successful Trim.
ZR-ERR	Set value outside of upper limits during Zero Trim	Check Limits
SP-ERR	Set value outside of upper limits during Span Trim	Check Limits
-ZR-	Zero /LRL configuration with external PV initiated	LRL set up initiated
-SP-	SpanURL configuration with external PV initiated	URL setup initiated
-ZA-	Zero Adjustment done	Z-Adj accepted.
-DONE-	Setting Done using button	Changes accepted
RNGOVR	Over range	Check Limits
LCD_OV	Over range for LCD display	Check limits
SCD-ER	Sensor Code Error	Check Sensor
F-RST	Flash Setting Data Reset	Reboot
F-LOCK	While Flash Setting Data Reset, Protect Locked	Write Protect on
F-FAIL	Flash Setting Data Reset Failure	Initialize failed.
-FR-	Flash Reset Done	Initialize completed
A-RST	Analog EEPROM Initializing Start	Initialize initiated
A-STOR	Analog EEPROM Whole Write	Write initiated
A-FAIL	Analog EEPROM Whole Write Failure	Write fail
-AC-	Analog EEPROM Whole Write Done	Write completed
S-FL	Sensor Failure	Check sensor input
S-OP	Sensor PV exceed MWP	Check limits.
AEP-RF	Check sum error in EEPROM during read sequence	Reboot
AEP-WF	Check sum error in EEPROM during write sequence	Reboot
TS-FL	Temperature sensor failure	Replace
EOSC	Sensor Element defective	Replace
FAVE	Flash Access Violation	Reboot

APT3100

****** FOR CURRENT 7.X FIRMWARE PLEASE REFER TO ATTACHED ADDENDUM -A FOR THE LATEST MENU TREE.**

Appendix II Push Button Menu (Firmware Ver. 6.6 and higher)

Ver 6.6

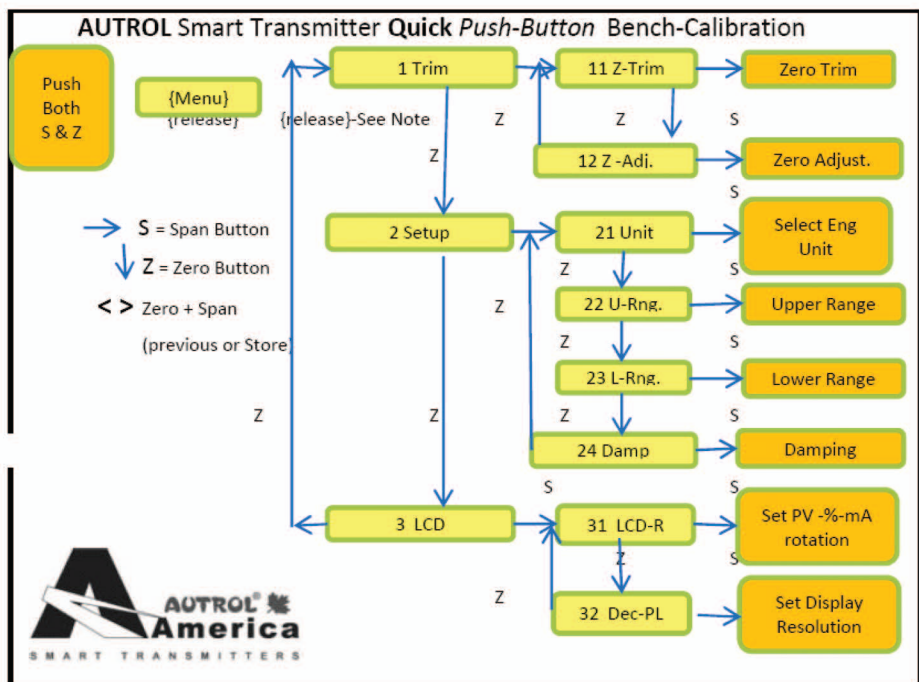

Note: One legit Keystroke is counted when 3 seconds pressed/1sec quick release if not correctly done display will show { BT Error}.

Also if after 5 seconds menu does not change release key and try again by pressing down harder. After 30 second inactivity automatically defaults back to measuring mode.

SUB-MENUS

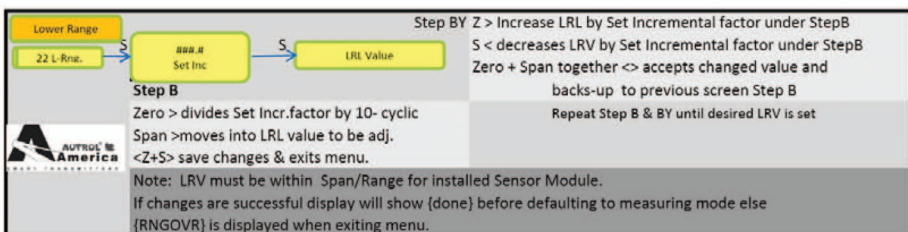
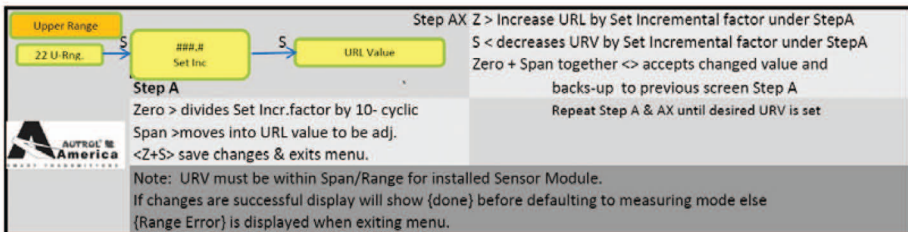

Appendix III **APT Configuration Manual for use with a HART® enabled HHC (Hand Held Communicator)**

Autrol® APT & ATT series Pressure & Temperature SMART transmitters are fully supported by HART® enabled external configurators. Basic Configurations can be accessed and configured using Generic HART® Drivers preinstalled on these third party configuration tools.

For Advanced Setup features Autrol® DDL (Device Descriptive Libraries) and DOF (Device Object Files) can be downloaded online from Hart® Foundation listing directories or HHC manufacturer's website at NO additional costs. However before uploading DDL (or DOF) files on to the HHC please follow the original manufacturer's instructions for proper tools/procedures defined for uploading or updating preinstalled older version DDL (or DOF) files on to their hardware.

In case full functionalities (as described in subsequent sections) are NOT supported on your HHC please make sure you have the most current DDL (or DOF) version installed on your hand held device.

All Autrol® transmitters have been tested prior to release of official DDL and DOF files for third party use, hence please check your installation and/or contact the original manufacturer of the hand held communicator first to make sure the HHC device firmware is up to date and relevant DDL files loaded are current and complement the latest release registered on Hart® Foundation listing online.

For additional questions please contact your nearest AAI office or email service@autroltransmitters.com

APT3100

MENU TREE (7.x)

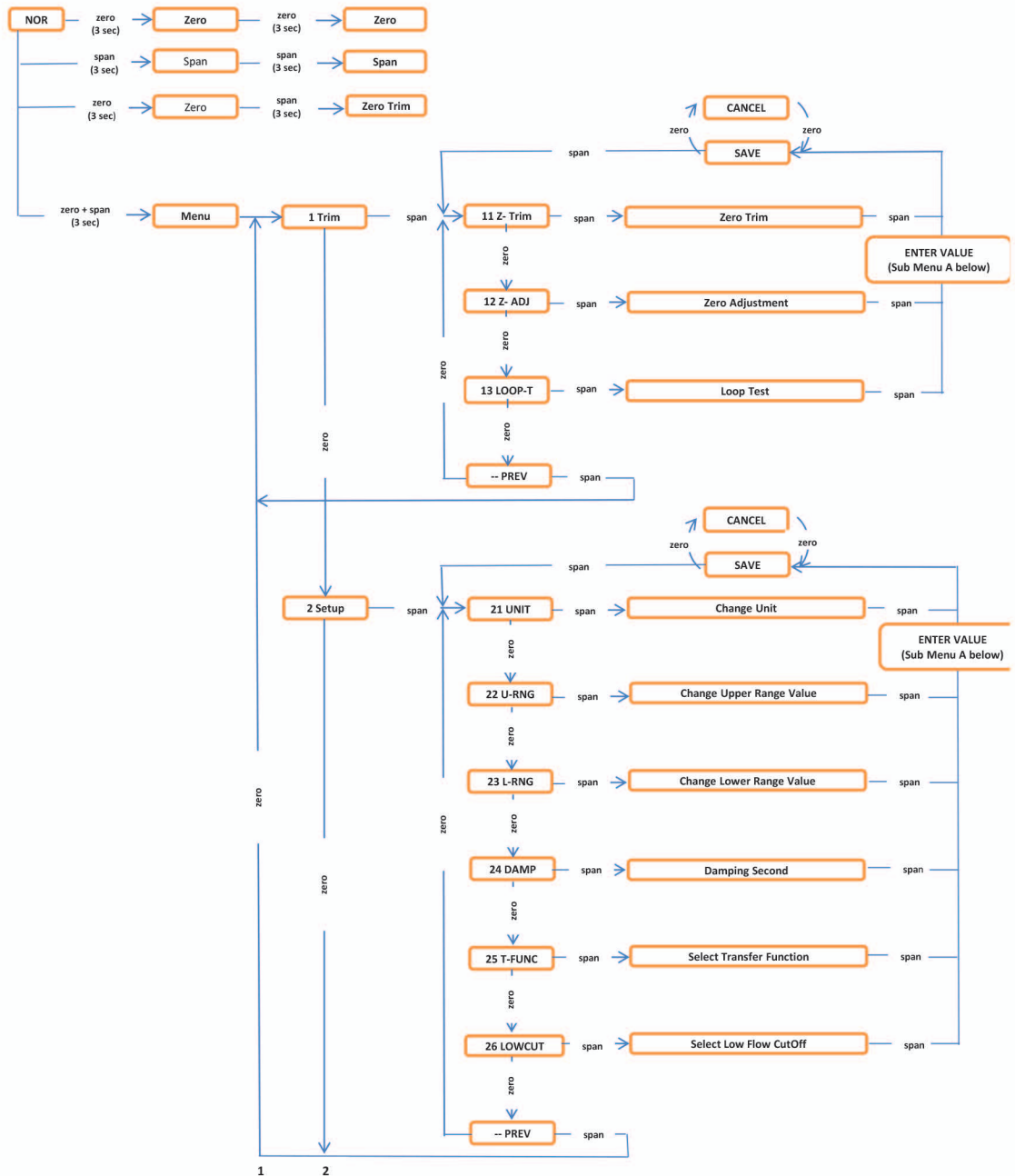

Continued next page----

Continued from previous page----

APT3100

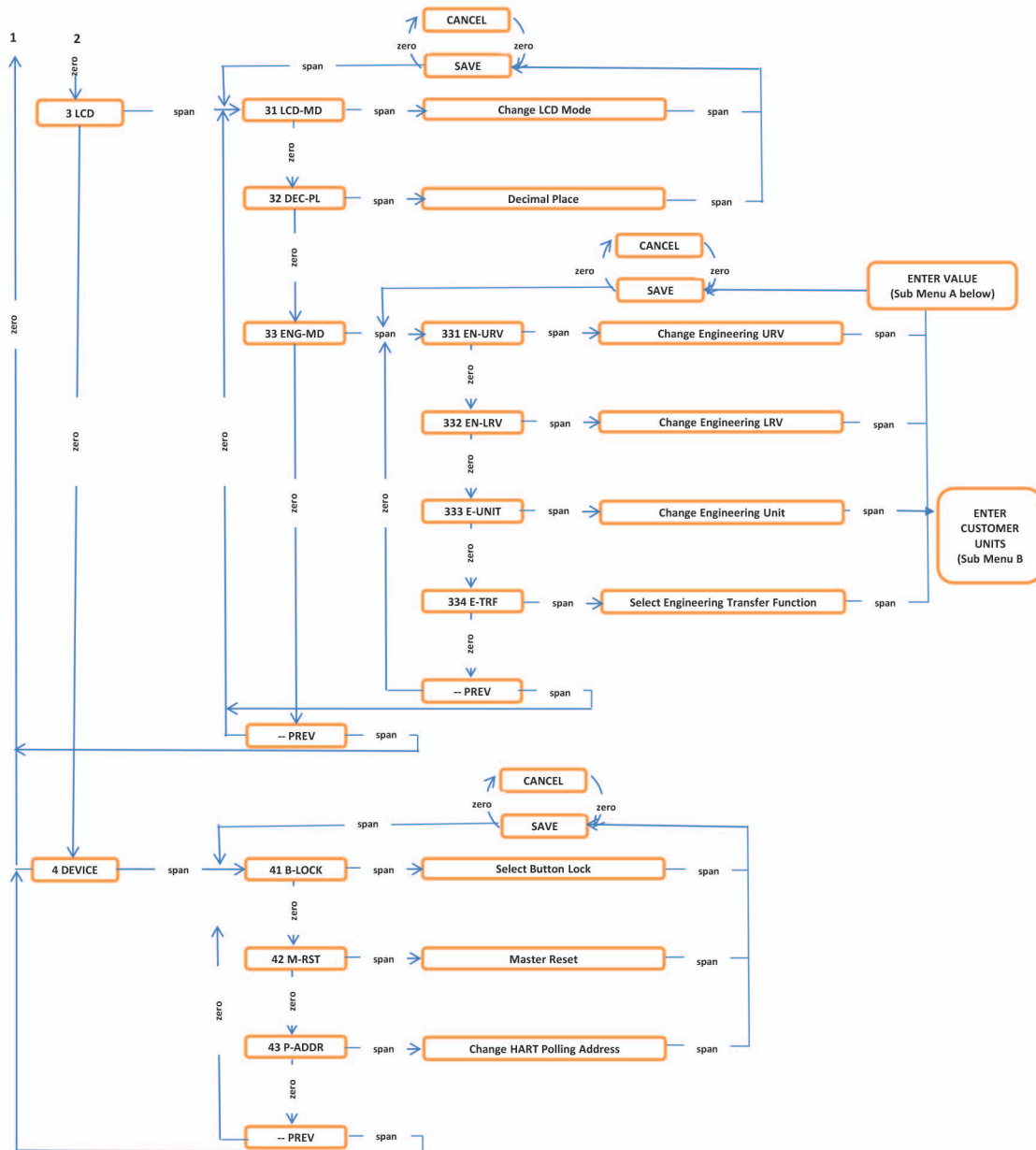

Continued from previous page----

APT3100

NUMERIC ENTRY SUB MENU -

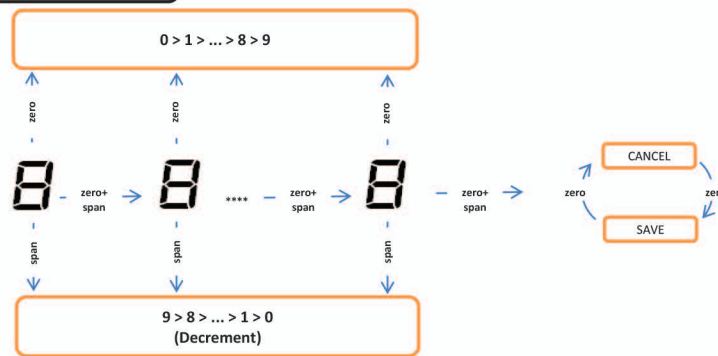

**ALPHA-NUMERIC ENTRY SUB
MENU - B**

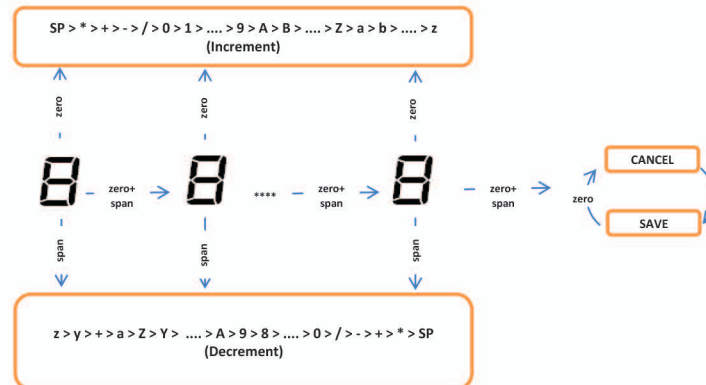

For more details please check out our videos in the download sections.